

MERIT BADGE SERIES

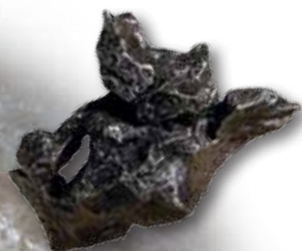

ASTRONOMY



BOY SCOUTS OF AMERICA®



HOW TO USE THIS PAMPHLET

The secret to successfully earning a merit badge is for you to use both the pamphlet and the suggestions of your counselor.

Your counselor can be as important to you as a coach is to an athlete. Use all of the resources your counselor can make available to you. This may be the best chance you will have to learn about this particular subject. Make it count.

If you or your counselor feels that any information in this pamphlet is incorrect, please let us know. Please state your source of information.

Merit badge pamphlets are reprinted annually and requirements updated regularly. Your suggestions for improvement are welcome.

Send comments along with a brief statement about yourself to Youth Development, S209 • Boy Scouts of America • 1325 West Walnut Hill Lane • P.O. Box 152079 • Irving, TX 75015-2079.

WHO PAYS FOR THIS PAMPHLET?

This merit badge pamphlet is one in a series of more than 100 covering all kinds of hobby and career subjects. It is made available for you to buy as a service of the national and local councils, Boy Scouts of America. The costs of the development, writing, and editing of the merit badge pamphlets are paid for by the Boy Scouts of America in order to bring you the best book at a reasonable price.



BOY SCOUTS OF AMERICA
MERIT BADGE SERIES

ASTRONOMY



BOY SCOUTS OF AMERICA®

Requirements

1. Do the following:
 - a. Describe the proper clothing and other precautions for safely making observations at night and in cold weather.
 - b. Tell how to safely observe the Sun, objects near the Sun, and the Moon.
 - c. Explain first aid for injuries or illnesses such as heat and cold reactions, dehydration, bites and stings, and damage to your eyes that could occur during observation.
2. Explain what light pollution is and how it and air pollution affect astronomy.
3. With the aid of diagrams (or real telescopes if available), do each of the following:
 - a. Explain why binoculars and telescopes are important astronomical tools. Demonstrate or explain how these tools are used.
 - b. Describe the similarities and differences of several types of astronomical telescopes.
 - c. Explain the purposes of at least three instruments used with astronomical telescopes.
 - d. Describe the proper care and storage of telescopes and binoculars both at home and in the field.
4. Do the following:
 - a. Identify in the sky at least 10 constellations, at least four of which are in the zodiac.
 - b. Identify at least eight conspicuous stars, five of which are of magnitude 1 or brighter.
 - c. Make two sketches of the Big Dipper. In one sketch, show the Big Dipper's orientation in the early evening

sky. In another sketch, show its position several hours later. In both sketches, show the North Star and the horizon. Record the date and time each sketch was made.

- d. Explain what we see when we look at the Milky Way.
5. Do the following:
 - a. List the names of the five most visible planets. Explain which ones can appear in phases similar to lunar phases and which ones cannot, and explain why.
 - b. Using the Internet (with your parent's permission), books, and other resources, find out when each of the five most visible planets that you identified in requirement 5a will be observable in the evening sky during the next 12 months, then compile this information in the form of a chart or table.
 - c. Describe the motion of the planets across the sky.
 - d. Observe a planet and describe what you saw.
 6. Do the following:
 - a. Sketch the face of the Moon and indicate at least five seas and five craters. Label these landmarks.
 - b. Sketch the phase and the daily position of the Moon, at the same hour and place, for four days in a row. Include landmarks on the horizon such as hills, trees, and buildings. Explain the changes you observe.
 - c. List the factors that keep the Moon in orbit around Earth.
 - d. With the aid of diagrams, explain the relative positions of the Sun, Earth, and the Moon at the times of lunar and solar eclipses, and at the times of new, first-quarter, full, and last-quarter phases of the Moon.
 7. Do the following:
 - a. Describe the composition of the Sun, its relationship to other stars, and some effects of its radiation on Earth's weather and communications.
 - b. Define sunspots and describe some of the effects they may have on solar radiation.
 - c. Identify at least one red star, one blue star, and one yellow star (other than the Sun). Explain the meaning of these colors.

8. With your counselor's approval and guidance, do ONE of the following:
 - a. Visit a planetarium or astronomical observatory. Submit a written report, a scrapbook, or a video presentation afterward to your counselor that includes the following information:
 - (1) Activities occurring there
 - (2) Exhibits and displays you saw
 - (3) Telescopes and other instruments being used
 - (4) Celestial objects you observed
 - b. Plan and participate in a three-hour observation session that includes using binoculars or a telescope. List the celestial objects you want to observe, and find each on a star chart or in a guidebook. Prepare an observing log or notebook. Show your plan, charts, and log or notebook to your counselor before making your observations. Review your log or notebook with your counselor afterward.
 - c. Plan and host a star party for your Scout troop or other group such as your class at school. Use binoculars or a telescope to show and explain celestial objects to the group.
 - d. Help an astronomy club in your community hold a star party that is open to the public.
 - e. Personally take a series of photographs or digital images of the movement of the Moon, a planet, an asteroid, meteor, or a comet. In your visual display, label each image and include the date and time it was taken. Show all positions on a star chart or map. Show your display at school or at a troop meeting. Explain the changes you observed.
9. Find out about three career opportunities in astronomy. Pick one and find out the education, training, and experience required for this profession. Discuss this with your counselor, and explain why this profession might interest you.

Contents

Introduction: Reach for the Stars	7
Getting Ready to Observe	8
Stars and Constellations.	13
The Planets and Our Solar System.	27
The Moon—Our Nearest Neighbor.	39
The Sun and Stars.	47
Tools of the Trade	55
Light Pollution.	67
You and Astronomy	69
Careers in Astronomy	73
Astronomy Resources	77





Introduction: Reach for the Stars

Spectacular shows can be seen in the night sky. From Earth, we can see *nebulae*, or giant clouds of gas and dust where new stars are born. We can see old stars dying and exploding. We can see meteor showers, or shooting stars. Sometimes it is rare to see some of these sights. But on any clear night of the year, you usually can see the Moon and a dazzling array of stars.

In learning about astronomy, you will study how activities in space affect your own planet. Your daily schedule—daytime and nighttime—is dictated by Earth’s position as it rotates on its axis. Earth’s orbit around the Sun takes a year and gives us the changing seasons. The Sun’s energy affects the weather, and the gravitational pull between Earth and the Moon creates and controls ocean tides.

We still have much to learn about space. Only a few years ago, in 2001, astronomers discovered 11 new moons orbiting Jupiter. Through instruments such as the Hubble Space Telescope, we see visions today that earlier observers could not have imagined.

We know much about space and its effects on us, but there is a great deal we don’t yet know. Someday you might be among the scientists or the serious amateur observers who make important new discoveries.

An *axis* is the imaginary line around which a rotating body, such as Earth, turns. Earth’s axis is a straight line between the geographic (not magnetic) north and south poles. Earth’s *orbit* is the curved path it follows on its yearly trip around the Sun.

Just as you enjoy looking up at the stars and finding the Big Dipper, ancient stargazers had fun naming the patterns of stars they saw every night. The word *astronomy* literally translates to “naming the heavens.”

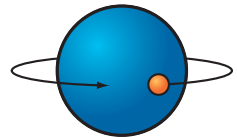

REVOLUTION

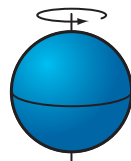

ROTATION



Getting Ready to Observe

Know how to protect yourself before you go out in search of the next great astronomical discovery.

Protect Your Body

When you go stargazing, dress appropriately for the weather—hot or cold. To help protect yourself against bites and stings when you go outside, wear clothes that cover all exposed skin, and be sure to button and tuck them in. Wear shoes or boots—not sandals—and socks. Insect repellent sprayed on your body, clothing, and shoes provides added protection.

Many insect repellents contain chemicals that may corrode plastic. Whenever you are applying insect repellent, do so where it won't affect your equipment. Afterward, clean your hands before handling a telescope.



Moving in the Dark

During the day before a stargazing outing, survey the area where you will be observing. Look for drop-offs, holes, crevices, or other objects like large rocks or tree roots that you might not see at night. Take care to avoid the hazards when you return at night to observe. Bring red-filtered flashlights to illuminate the area.

It takes about 30 minutes for the human eye to adjust to darkness. To help preserve your night vision, use a red filter with your flashlight. Simply secure a piece of red cellophane over an ordinary flashlight.

Protect Your Eyes

Never stare directly at or near the Sun, even for a few moments. **Never** look at the Sun through binoculars or a telescope unless your equipment has the proper solar filters. Looking directly at the Sun—even while wearing sunglasses—can cause permanent blindness or other damage to your eyes that might not be immediately noticeable. *The safest way to observe the Sun is indirectly by projection*, which is explained in the chapter called “The Moon—Our Nearest Neighbor.” Projection is the recommended method for safely viewing the sun. In any case, always do so only under the supervision of a knowledgeable adult.

Observing Objects Near the Sun

Mercury, the planet nearest the Sun, always lies close to the Sun in the sky. Look for Mercury only when the Sun’s disk is entirely below the horizon. Don’t risk getting the Sun in the view. This could cause permanent eye damage or blindness.

If you are in the Sun and you or a companion experience eye discomfort, cover the eyes and seek medical attention immediately.

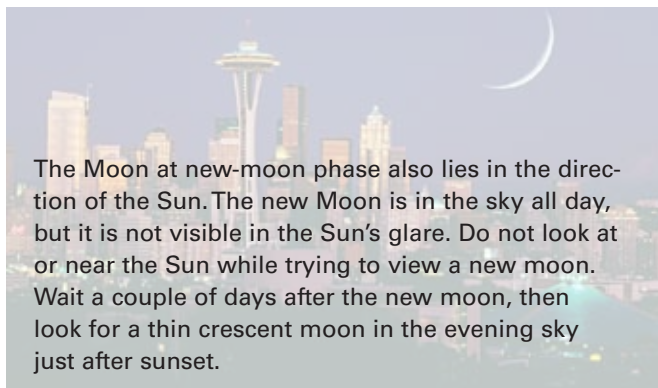

Heat Exhaustion and Heatstroke

Heat exhaustion occurs when the body overheats because its cooling methods fail. Watch for these signs: body temperature between 98.6 and 102 degrees; skin pale, clammy, and sweaty; nausea, dizziness, and fainting; pronounced weakness and tiredness; headache; muscle cramps. To treat heat exhaustion, have the victim lie down in a cool spot with the feet raised. Loosen the clothing. Apply cool, damp cloths to the skin or use a fan. Have the victim sip water.

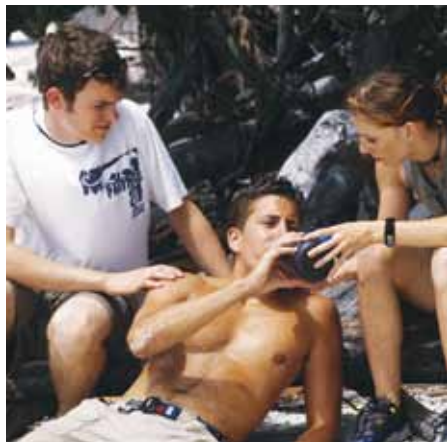

Heatstroke (sunstroke) is life-threatening because the body's heat control system has been overworked and overwhelmed, resulting in its failure. Signs include body temperature above 102 degrees; red, hot, and dry skin; extremely rapid pulse; confusion or disorientation; fainting or unconsciousness; convulsions.

Cool the victim immediately. Place the victim in a cool spot face-up with head and shoulders raised. Remove outer clothing, sponge the bare skin with cold water, and soak underclothing with cool water. Apply cold packs, use a fan, or place the victim in a tub of cold water. Dry the skin after the body temperature drops to 101 degrees. Obtain medical help immediately.

Sunburn

Sun exposure can catch you by surprise when you are outside, preoccupied with setting up your equipment or viewing a solar eclipse. Wear loose-fitting clothing that completely covers the arms and legs, and a brimmed hat. Apply sunscreen with a sun protection factor (SPF) of at least 15 to exposed skin. Don't forget your ears and the back of your neck. Reapply sunscreen often and as needed.

Cold-Related Problems—Hypothermia

Hypothermia occurs when the body's core temperature drops so low that it is no longer able to keep warm. The key to preventing hypothermia is to keep warm and stay dry, and—if you will be outside for extended periods—eat plenty of energy foods (nuts, dried fruits, peanut butter). Don't push yourself to a dangerous point of fatigue.

A person in the early stages of hypothermia may be shivering. As the victim gets colder, the shivering will stop. Other symptoms may include irritability, sleepiness, incoherence, disorientation, and the inability to reason or think clearly. Immediately prevent further heat loss. Move the victim to a shelter, remove damp clothing, and warm the person with blankets until body temperature returns to normal. Cover the head with a warm hat or other covering, and offer hot drinks.

If the condition progresses, actively warm the victim's body. Place the victim into a sleeping bag with one or two other people. All should be stripped of most clothing so that skin-to-skin contact can hasten the warming—and perhaps save a life. Severe hypothermia requires immediate medical attention.

In cold weather, wear layers to keep in the heat. Bring along a woolen cap, scarf, gloves, extra socks, and a coat. Keep your arms and legs covered. Always carry rain gear.



Dehydration

Dehydration is caused by lack of water in the body. A person who gives off more water than consumed can become dehydrated—in hot *or* cold weather. Astronomical observers should stay well-hydrated while in the outdoors. Do not wait to drink until you feel thirsty.



Circumpolar star chart

Stars and Constellations

People have always enjoyed studying the stars. To help them keep track of the stars, ancient Greeks creatively drew imaginary lines between stars to form images of mythological characters or other familiar creatures. These star groups are known as *constellations*. Today, astronomers recognize 88 constellations.

Year-Round Constellations

Some constellations are visible any time of the year. These constellations are known as *circumpolar* because they never set below the horizon. As Earth rotates on its axis, the stars seem to circle a point called the celestial north pole. The north pole itself points to Polaris, or the North Star. Finding Polaris will be a big help in locating the four main circumpolar constellations.

Ursa Major. The Big Dipper is part of Ursa Major (the Great Bear), a constellation that includes a few less-visible stars. The outer stars on the bowl of the Big Dipper always point to Polaris. Every six hours, the Big Dipper appears to have moved a quarter of the way around Polaris.

Ursa Minor. The Little Dipper, with stars fainter than the Big Dipper, is part of the constellation Ursa Minor, or the Little Bear. Polaris is the end of the Little Dipper's handle.

Cassiopeia. If you follow the line from the middle star of the Big Dipper's handle through Polaris, you will find Cassiopeia. Its five main stars form an M when they're above the North Star and a W when they are below it.

Draco. Draco, the dragon, winds around Polaris between the Big and Little Dippers. None of its more than 80 visible stars is very bright; the four stars that form the dragon's head are easiest to see.

A *star* is a hot, glowing ball of gas that produces energy by nuclear reactions in its core. In fact, our sun is a star.

A *constellation* is a pattern of stars in the sky.

Seasonal Constellations

Some constellations are visible in the night sky only at certain times of the year. Twelve seasonal constellations known as zodiacal constellations are centered on the *ecliptic*, the path that the Sun, the Moon, and the planets all appear to follow through the sky. The zodiacal constellations you can see at night—Aries, Taurus, Gemini, Cancer, Leo, Virgo, Libra, Scorpius, Sagittarius, Capricornus, Aquarius, and Pisces—change as Earth follows its yearly path around the Sun.

Spring Constellations

Leo. You can see Leo, the Lion, from January through June. From the two stars of the Big Dipper's bowl that are *not* used to point toward Polaris, follow with your eye a line straight down to Leo's brightest star, Regulus.

Virgo. Virgo, the Virgin, is the largest constellation and is visible from April through July. If you look from the handle of the Big Dipper through Arcturus (a bright star in the constellation Boötes), you will see another bright star. This is Spica, the bottom of Virgo's Y shape.

Libra. Libra, the Balance Scale, is a late-spring constellation with four fairly dim stars. It is one of the most difficult zodiacal star patterns to spot. Look between Spica and the southeastern horizon.

Cancer. Cancer, the Crab, is visible from January to May, but it is the faintest constellation in the zodiac. To find it, follow a line from Leo's Regulus to the Gemini constellation (a winter constellation described below). Cancer is between Leo and Gemini.

Some people believe the zodiacal constellations affect human behavior. This belief is known as astrology.

A *galaxy* is an enormous group of millions or billions of stars, bound together by gravity. Earth is in the Milky Way galaxy.

Summer Constellations

Lyra. You can see Lyra, the Lyre, from May through November. In late summer at about 10 P.M., if you look straight up, you may see a very bright blue-white star. This star, Vega, is Lyra's brightest star.

Cygnus. Often called the Northern Cross, Cygnus the Swan is visible from June through November. Follow a line from Vega slightly east to another star, Deneb, that is almost as bright. Deneb is Cygnus's brightest star.

Of the conspicuous (easy-to-see) stars, only Sirius and Arcturus are brighter than Vega.

Aquila. The somewhat triangular grouping in the summer sky south of Lyra and Cygnus is Aquila, the Eagle. Its brightest star is Altair, which forms the Summer Triangle with Deneb and Vega.

Part of Aquila lies along the path of the Milky Way where there are dense star fields.

Scorpius. In July and August, you can see Scorpius, the Scorpion, very close to the southern horizon. Its brightest star is Antares, a red supergiant star near the scorpion's head.

Sagittarius. In July and August you can see Sagittarius, the Archer, just east of Scorpius. Its main stars form a pattern that resembles a teapot. When you look at Sagittarius, you're looking toward the center of the Milky Way galaxy. Scorpius and Sagittarius may be difficult to view if you live in the North.

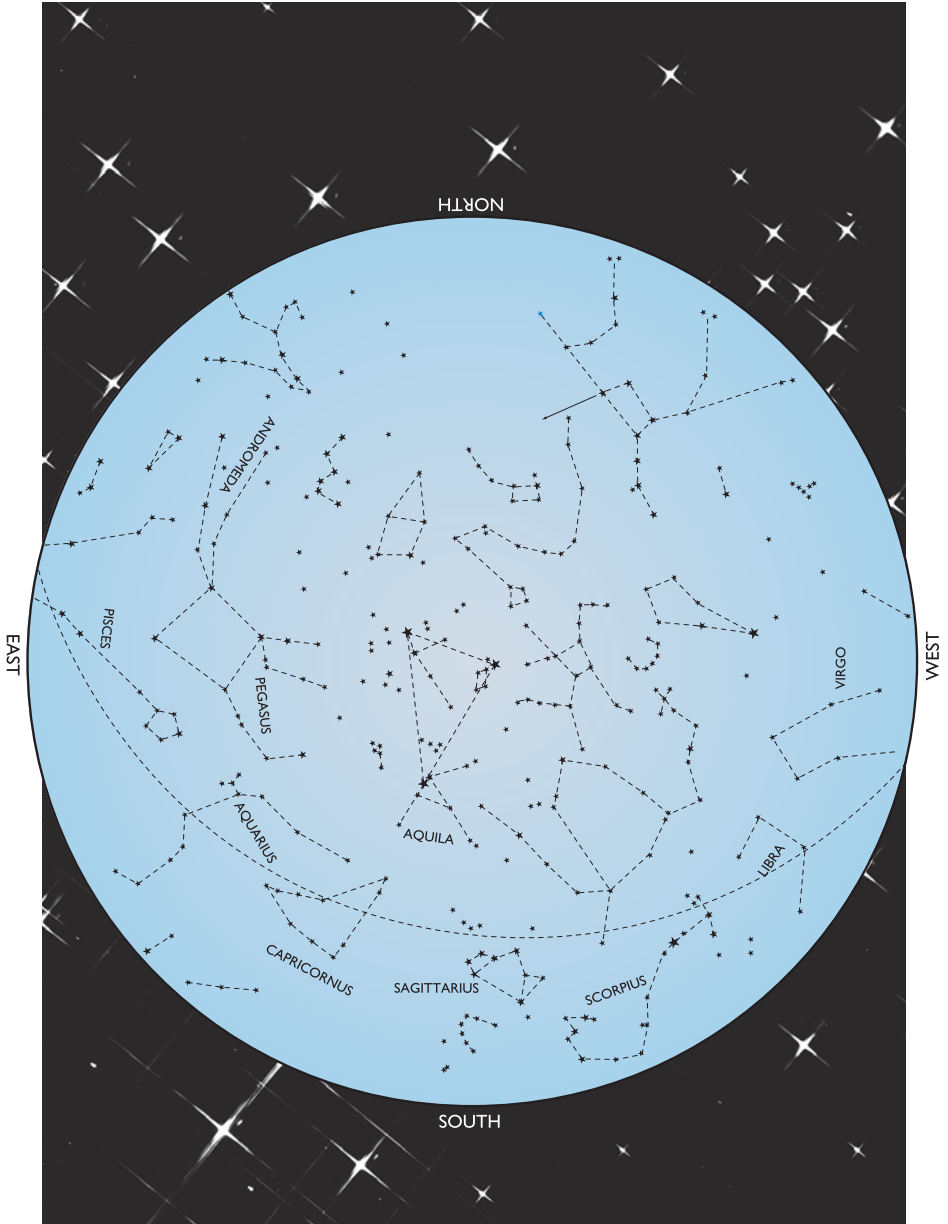

Summer star chart

To locate the
Circlet, an
interesting star
group in Pisces,
look just south of
the Great Square
of Pegasus.

Autumn Constellations

Pegasus. Pegasus, the Flying Horse, is best seen from August through October, southeast of Cygnus. Part of the constellation is known as the Great Square, an easy shape to recognize.

Andromeda. Pegasus shares one of its stars with Andromeda, which is visible from September to January. Look eastward from the Great Square of Pegasus. The Andromeda galaxy—the most distant object visible to the naked eye—is visible on clear nights as a faint, misty spot in the Andromeda constellation.

Perseus. You can see Perseus in the autumn and winter, east of Andromeda. It lies between the constellations of Auriga (described below) and Cassiopeia. Perseus contains the double star Algol. As the stars of Algol pass in front of each other, Algol appears alternately fainter and brighter.

A double star is a pair of stars that are close together and hold each other captive by the force of gravity. Each one orbits around the other. In most cases they are so close together, they look like single stars.

Aries. Three fairly bright stars make up the main part of Aries, the Ram. It appears south of Andromeda from October through March.

Pisces. The main part of Pisces, the Fishes, is a string of stars below Andromeda and Pegasus. Pisces appears in the sky from October to December, but it is faint and can be hard to find.

Capricornus. Look straight down from the star Altair in Aquila. Capricornus, the Sea Goat, is a faint constellation, but when visibility is good you can see it from August through October.

Aquarius. On dark, clear nights from August through October, you may be able to see Aquarius, the Water Bearer, south of Pegasus. One end of Aquarius stretches above Capricornus and the other is below the Circlet of Pisces.

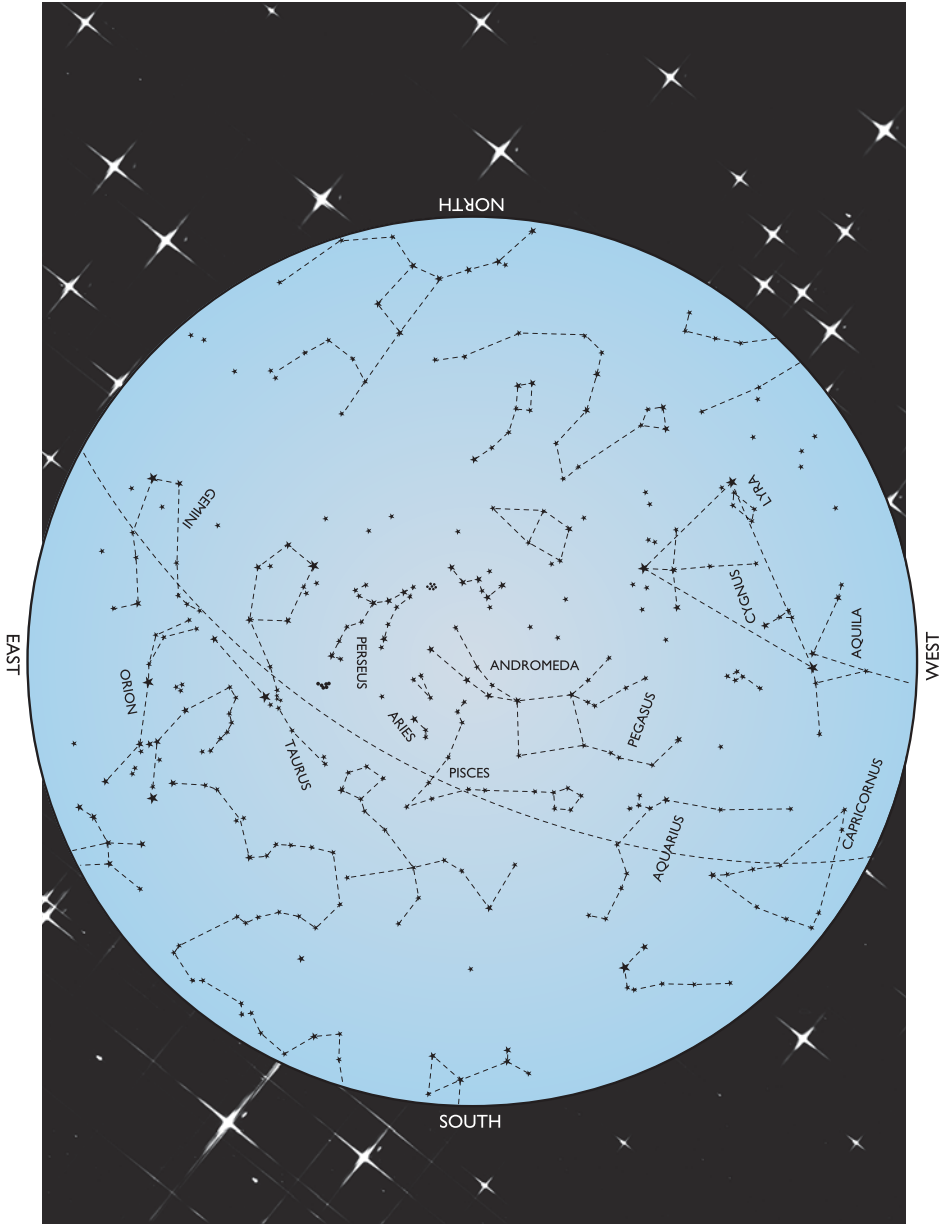

Autumn star chart

Betelgeuse, Orion's shoulder star, is so huge that if it were at the center of our solar system, its edges would extend beyond the orbit of Mars.

Winter Constellations

Orion. Orion, the Hunter, usually is easy to find from October through April. It is large and distinctive with two very bright stars—the reddish-orange giant Betelgeuse and bluish-white Rigel—as well as five other bright stars and several less visible ones. The Orion Nebula, a cloud of dust and gas several light-years across, is visible to the naked eye as a fuzzy patch just below Orion's belt.

Canis Major. Southeast of Orion is Canis Major, the Great Dog, which you can see from December through April. Sirius, the night sky's brightest star, is a part of Canis Major. Orion's three belt stars point downward toward Sirius.

Gemini. From December through May you can see Gemini, the Twins, northeast of Orion. Two bright stars, Castor and Pollux, are the heads of the Gemini twins.

Auriga. Visible from November through April, Auriga, the Charioteer, is north of Orion. Capella, a double star in Auriga, is one of the brightest lights in the sky.

Taurus. Orion's belt stars point up toward Aldebaran, a bright orange-red star. Aldebaran is the eye of Taurus the Bull, a constellation you can see from November through March.

Taurus has two star groups: one a cluster of stars known as the Pleiades, and the other a larger, more scattered, V-shaped group known as the Hyades.

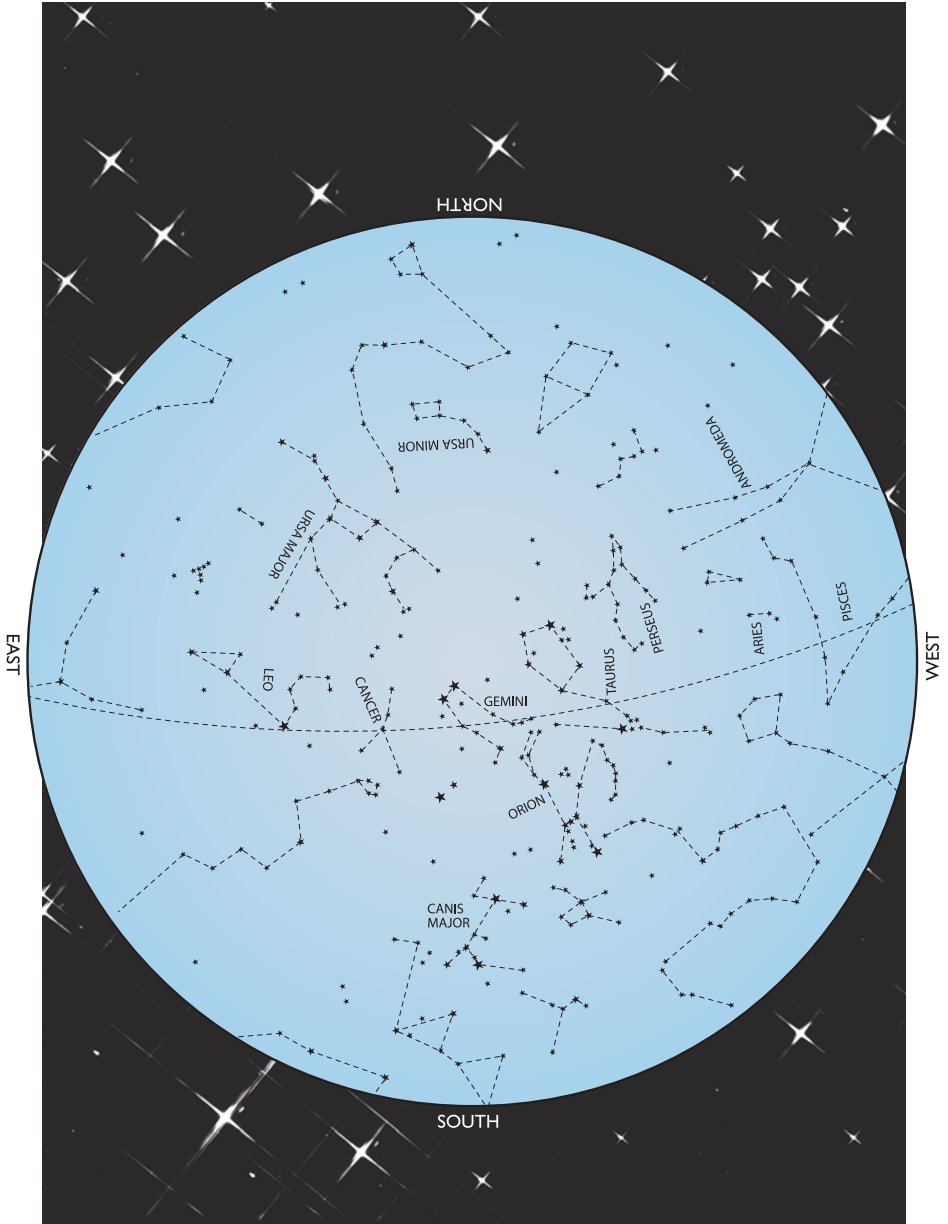

Winter star chart

Star Light, Star Bright

Another word astronomers use to describe a star's brightness is *magnitude*.

- *Absolute magnitude* refers to a star's true brightness—that is, the brightness if all stars were viewed from the same distance.
- *Apparent magnitude* means the brightness of a star as we see it from Earth. Astronomers give a star a number to refer to this magnitude. The lower the magnitude number, the brighter the star. Stars that are brighter than a magnitude 1 have a zero or negative number. The unaided human eye can see stars with a magnitude number as high as 6.

Listed here are some of the brightest stars in the sky, the constellations where they are found, and their apparent magnitude.

Star	Constellation	Magnitude
Sirius	Canis Major	-1.46
Arcturus	Boötes	-0.04
Vega	Lyra	0.03
Capella	Auriga	0.08
Rigel	Orion	0.12
Procyon	Canis Minor	0.38
Betelgeuse	Orion	0.5
Altair	Aquila	0.77
Aldebaran	Taurus	0.85
Antares	Scorpius	0.96
Spica	Virgo	0.98
Pollux	Gemini	1.14
Deneb	Cygnus	1.25



If you live outside a major city, you probably have seen the Milky Way, which can be viewed without the aid of a telescope or binoculars.

The Milky Way

When we look at the Milky Way in the night sky, we see our own galaxy. Apart from other galaxies, everything we see in the night sky—the stars, star clusters, nebulae, the Sun, the Moon, and the planets—is part of the Milky Way. Just as its name implies, it appears as a whitish band of light. For observers in the northern hemisphere, it is brightest in the summer months in the constellations Aquila and Cygnus.

The Milky Way is our home galaxy, a gigantic disk of hundreds of billions of stars and vast quantities of dust and gas. It is about 100,000 light-years across and some 10,000 light-years thick at its center. Stars, dust, and gases fan out from the hub of this huge whirling disk in long, curving arms that make a spiral or pinwheel shape. Our solar system is about halfway out from the center on one of the arms.

Every one of the billions of galaxies in the universe has millions or billions of stars. The Milky Way appears to be an average spiral galaxy.

The Andromeda Galaxy is more than 2 million light-years away. A *light-year* is the distance light travels in one year, equal to approximately 5.9 trillion miles.



You can see another galaxy with the unaided eye on a clear night in the fall—the Andromeda Galaxy. It also is the most distant object you can see with the naked eye. It appears as a misty patch of light in the constellation of Andromeda. Astronomers call the Andromeda Galaxy “M31” and place it at about 2.4 million light-years from Earth. M31 appears to be half again as big as our galaxy—150,000 light-years across.

Some galaxies can be seen through backyard telescopes at distances of 100 million light-years or more—distances almost unimaginable.

Using a Planisphere

A *planisphere* is a flat, circular map of the stars with an overlay that you can set to show what stars and constellations are visible at any time of the night and any night of the year. It can be adjusted to match the exact month, day, and hour when you are looking at the sky.



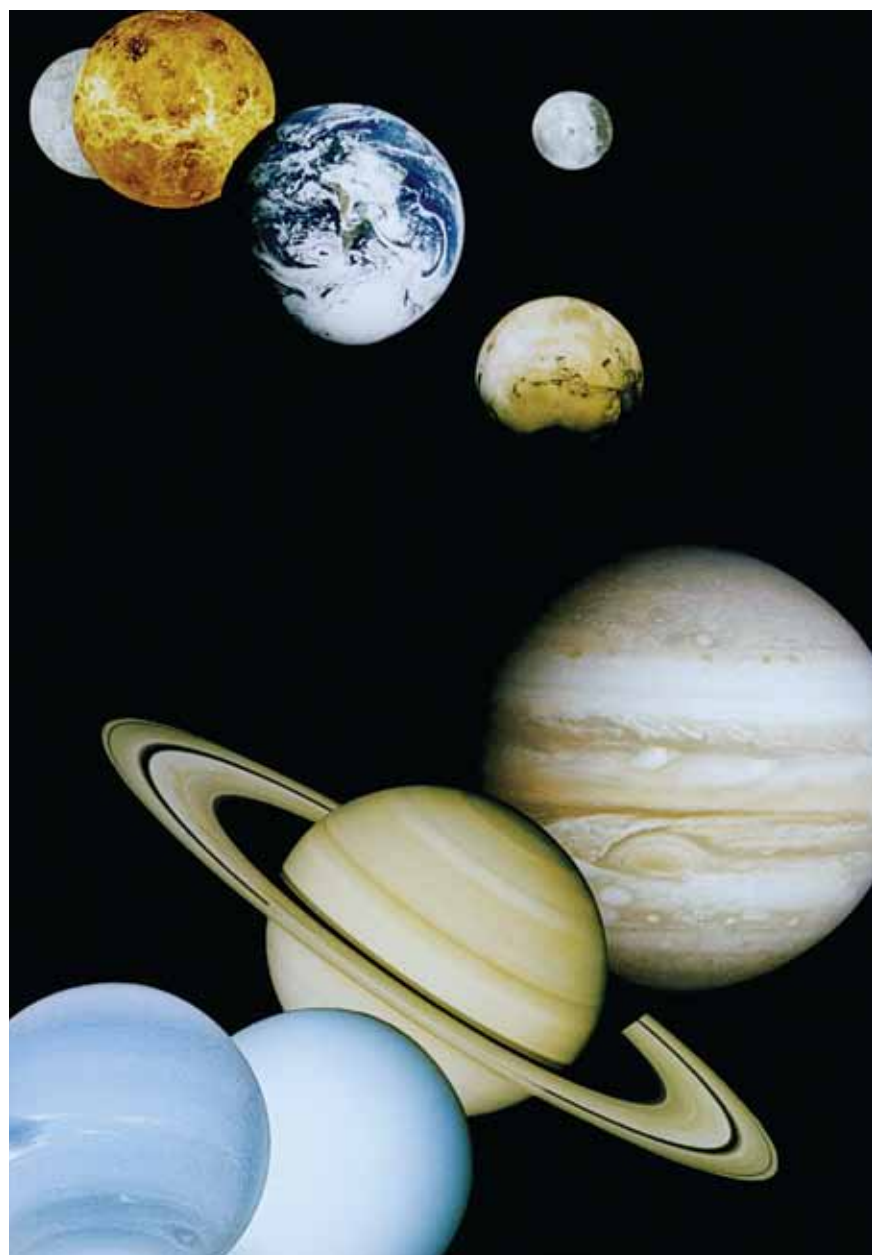

The Planets and Our Solar System

The planets of our solar system travel around the Sun, each in its own orbit. The four planets closest to the Sun—Mercury, Venus, Earth, and Mars—are called the terrestrial (earthlike) planets because they have solid, rocky surfaces. The four large planets beyond the orbit of Mars—Jupiter, Saturn, Uranus, and Neptune—are the gas giants, made mostly of hydrogen and helium, probably with no solid surfaces.

Mercury is the small, rocky planet nearest the Sun. It completes a trip around the Sun every 88 Earth-days, speeding in its orbit faster than any other planet in the solar system. If you could stand on Mercury, you would see a bloated sun creep at a snail's pace through a black sky. Mercury rotates extremely slowly on its axis—once in about 59 Earth-days. Because Mercury is so close to the Sun, temperatures on the planet's surface can reach a searing 800 degrees. Mercury's cratered surface looks much like the surface of Earth's moon.

Venus, second planet from the Sun, is only slightly smaller than Earth. The thick clouds of carbon dioxide and sulfuric acid that cover Venus reflect sunlight, making it bright but also trapping heat at the planet's surface. At 842 degrees, it's hotter on Venus than on Mercury, even though Mercury is nearer the Sun. The thick, heavy atmosphere creates enormous pressure on Venus. Space probes that have landed there have lasted only a few hours before the pressure crushed them. Venus spins in the opposite direction of its orbit around the Sun.



Mercury



Venus is a scorched world with temperatures hot enough to melt lead.



Earth



Mars



Jupiter

Life on **Earth** survives beneath a thin layer of atmosphere that shelters us from the dangers of space. “Ocean” might be a more appropriate name for this planet, because oceans cover nearly 70 percent of Earth’s surface.

Mars, the red planet, is the fourth terrestrial planet. A day on Mars lasts 24 hours, 37 minutes—only slightly longer than an Earth-day. But Mars takes almost twice as long as Earth to orbit the Sun, going around once in 687 Earth-days.

Though Mars is a world with no rivers, it has winding valleys that look like dry riverbeds. Scientists believe that powerful floods once deluged Mars. Today the planet is too cold and its atmosphere too thin for liquid water to exist at the surface. In 2002, the Mars Odyssey spacecraft detected large amounts of ice near the surface—enough to fill Lake Michigan twice over. More water is frozen in the polar ice caps.

Jupiter, more than 300 million miles from Mars, is the largest planet in the solar system. If Jupiter were a hollow ball, more than a thousand Earths would fit inside. Despite its size, Jupiter spins faster than any other planet, rotating every 10 hours. However, it takes Jupiter nearly 12 Earth-years to orbit the Sun. Like the other gas giants, Jupiter is mostly hydrogen and helium. The temperature at the top of its colorful clouds is minus 220 degrees. Down in the clouds, the temperature reaches 70 degrees at a depth where the atmospheric pressure is about 10 times as great as it is on Earth.

Three Earths could fit across Jupiter's Great Red Spot, a storm like a hurricane that has raged for centuries in Jupiter's southern hemisphere.

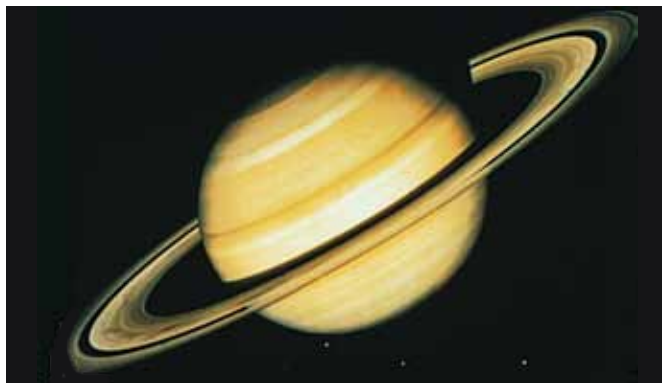

Saturn with its rings would just fit in the distance between Earth and the Moon.

Saturn

Saturn, the second largest planet, is the farthest from Earth of the five planets known to early stargazers. Galileo, in 1610, was the first astronomer to see Saturn and its rings through a telescope. Up to 1977, astronomers thought Saturn was the only planet with rings. We now know the other gas giants—Jupiter, Uranus, and Neptune—also have ring systems, but Saturn's is by far the largest, most visible, and most complex. Its rings are made mostly of ice. Saturn also has at least 30 moons. The largest, Titan, is a little bigger than Mercury and is blanketed with a thick, nitrogen-rich atmosphere.

Uranus (pronounced YOOR-un-nus), a large gas planet, blue-green in color, was discovered in 1781 by astronomer William Herschel; its rings were not discovered until 1977. Uranus is twice as far from the Sun as Saturn—so far away that it takes sunlight about 2 hours, 40 minutes to reach it. Uranus orbits the Sun tipped on its side, the result of what many astronomers think was a collision with a planet-sized body long ago.

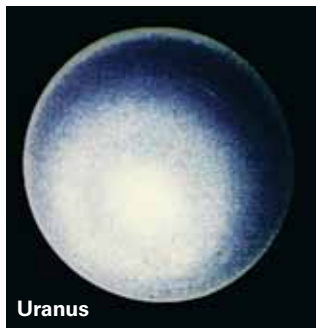

Uranus

Since its discovery in 1846, Neptune has yet to make one full circle around the Sun.



Neptune, the eighth planet from the Sun, is so far away that it takes 165 years to orbit the Sun. Like Earth, Neptune has seasons, but each season lasts for 41 Earth-years. Neptune is too distant to be seen with the unaided eye. In 1989, the Voyager 2 spacecraft tracked a large dark storm like a hurricane

in Neptune's southern hemisphere and discovered great geysers of nitrogen on Triton, Neptune's largest moon. Triton is the coldest body yet visited in our solar system, with surface temperatures reaching minus 390 degrees.

How the Planets Move

From our home planet, the Sun appears to circle Earth, rising in the east and setting in the west. But Earth really is the body that is moving. To understand the movements of the night sky, keep in mind Earth's two main motions: It circles the Sun, going around once in 365 days (a year), and it spins on its axis, making one complete rotation in 24 hours (a day).

From night to night, each planet shifts its position slightly eastward in relation to the stars, traveling "through" various constellations over the course of several weeks as it circles the Sun. Mercury, Venus, and Mars show this motion most clearly. Distant Jupiter and Saturn travel so slowly, it's harder to see their eastward shift against the stars.

Earth's counterclockwise spin—from west to east—makes the sky overhead seem to rotate in the opposite direction, from east to west. The Sun, the stars, the Moon, and the planets also appear to travel a simple westward path across the sky, but their patterns actually are more complicated.

The retrograde motion of the planets puzzled early astronomers, who named these bodies “planets,” which in Greek means “wanderers,” because of the complicated ways the planets move.

Sometimes, a planet exhibits *retrograde motion*—it appears to stop its eastward drift and loop back toward the west before resuming its normal west-to-east movement. For example, because Earth takes less time to orbit the Sun than outer planets like Mars, Jupiter, and Saturn, it occasionally overtakes an outer planet, like a fast car passing a slower one on the highway. As Earth approaches, the other planet appears to stop its eastward drift and loop back toward the west. As Earth swings past the planet, we see the planet resume its normal west-to-east drift in the night sky.

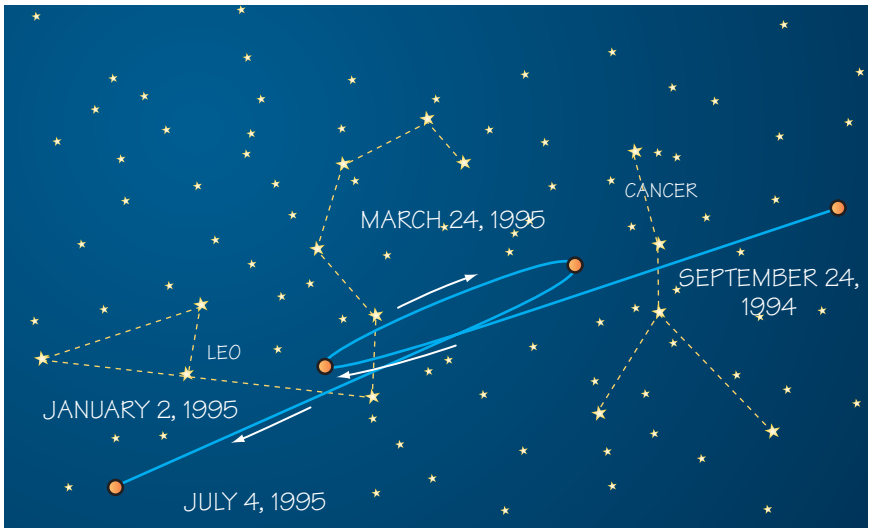

As Earth overtakes a planet that is farther from the Sun, the planet’s movement appears to change direction. This retrograde motion is most apparent in the movement of Mars from 1994 to 1995.

Observing the Planets

Never look at the Sun to locate Mercury, as blindness could result. Make sure the Sun's disk is completely below the horizon before looking in its direction.

Five planets are visible from Earth with the unaided eye: Mercury, Venus, Mars, Jupiter, and Saturn. Uranus may be dimly viewed on very clear nights, but only with powerful telescopes can we view Neptune even faintly.

The Inferior Planets

Mercury and Venus orbit the Sun inside Earth's orbit, so they are known as *inferior* planets. When these planets are between Earth and the Sun, the Sun's brightness make them invisible. Behind the Sun, they are out of sight. The best time to see these planets, therefore, is when they are on either side of the Sun.

Because Mercury is so close to the Sun, it is never seen in a fully dark, nighttime sky. It is visible only in bright twilight, either very low in the western sky just after sunset or very low in the east just before sunrise.

Late winter and early spring are usually the best times for observers in the northern hemisphere to spot tiny Mercury in the evening sky, about half an hour after sunset. To find it in the early morning sky, about half an hour before sunrise, look in the direction of sunrise during the late summer and fall.

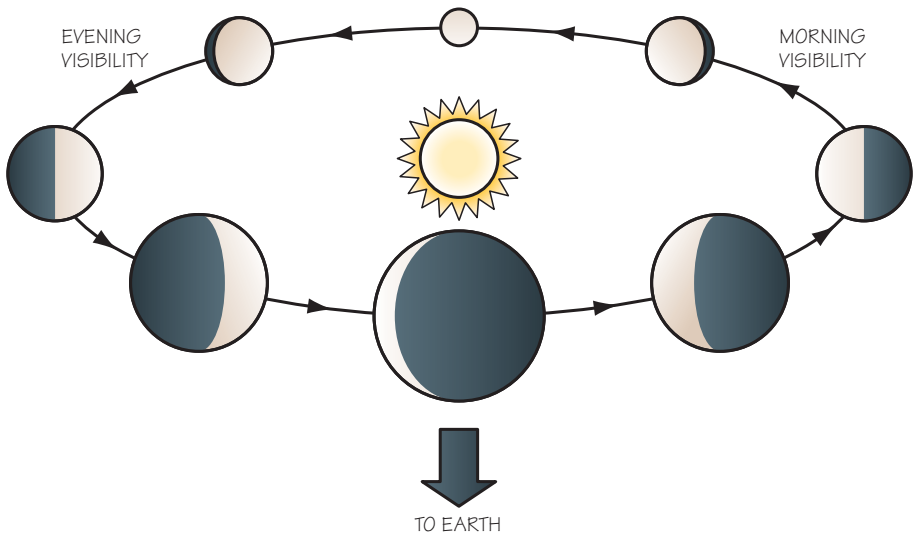

Mercury's phases

Venus also appears only in the early evening or early morning sky, but it is much easier to see than Mercury. Sometimes called the morning or the evening star, diamond-white and brilliant Venus is our solar system's brightest planet. If Venus is in the evening sky, you can't miss it.

Because different parts of their sunlit areas are visible from Earth at different times, Mercury and Venus have phases similar to the Moon's. At different times, they appear full, *gibbous* (three-quarters full), half-full (like a first-quarter or last-quarter moon), as a crescent, or anywhere in between.

When Mercury or Venus is on the same side of the Sun as Earth, the planet's unlit side faces Earth. As the planet moves around the Sun away from Earth, its sunlit side becomes visible as a thin crescent and grows gradually as the planet moves along. When Mercury or Venus is near the other side of the Sun, we can see almost all of its sunlit face—the full phase.

A *conjunction* occurs when two or more planets appear near each other in the sky. Major conjunctions—when several planets align—are rare celestial events that may occur decades apart. In May 2000, five planets lined up across the solar system. The next grand conjunction will not occur until September 8, 2040.

The Superior Planets

The planets beyond Earth's orbit are known as the *superior* planets. Unlike the inferior planets, which are always close to the Sun in our sky, the superior planets can appear anywhere in the sky on the ecliptic, and they always appear full. Mars, Jupiter, and Saturn can be seen high in the night sky, long after the sun has set.

The best time to view a superior planet is when it is in *opposition*—when Earth is directly between it and the Sun. When a planet is in opposition, it rises at sunset and sets when the Sun rises.

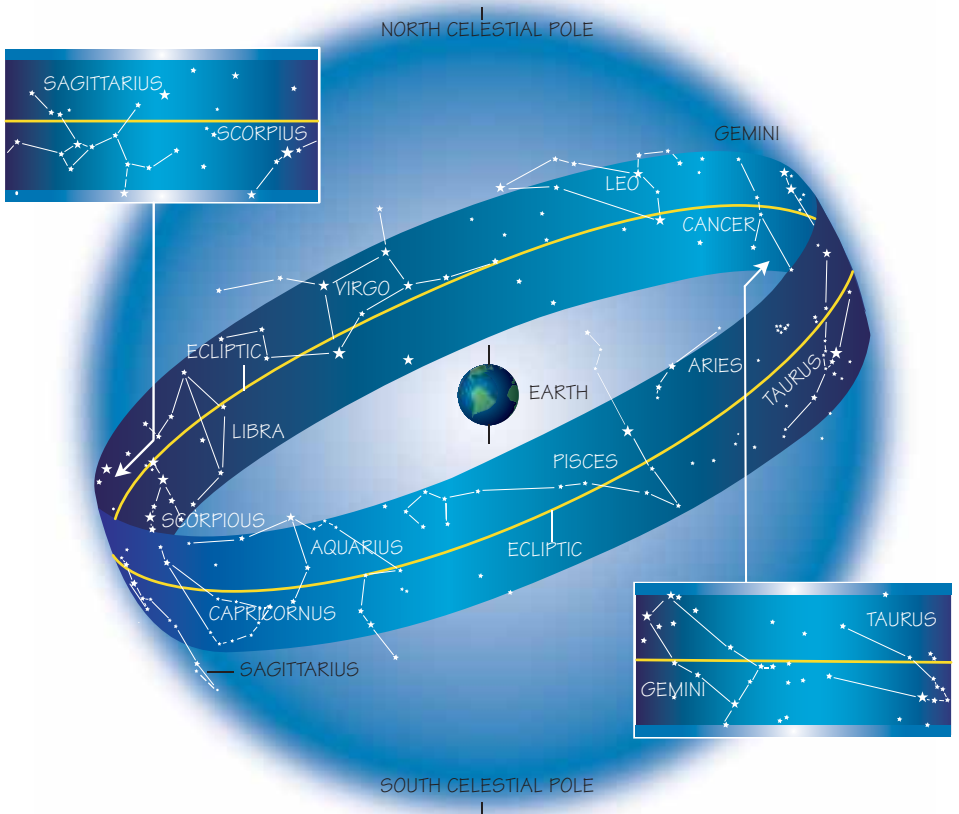

The zodiac is centered on the *ecliptic*, the path the Sun appears to follow among the stars.

Tracking Visible Planets

All the planets travel within the narrow band of the zodiac, although they wander around a bit, so they can be easy to miss. Even if you have a pretty good idea about the location of the zodiac, you may still have trouble finding the planets. For help, look at a sky map, which you can download from the Internet (with your parent's permission) or find at the local library. Here are a few tips on recognizing the planets.

Mercury. This small planet is hard to spot, but it is visible without a telescope, either just after sunset or just before dawn, always in the general direction of the Sun and never far from it.

Venus. After the Sun and Moon, Venus is the brightest object in the sky. It can sometimes be seen in daylight, but it is never more than three hours ahead of or behind the Sun.

Mars. Mars is called the Red Planet with good reason, but its brightness varies. Check its position in an astronomical almanac or guidebook.

Jupiter. Among the planets, Jupiter is second only to Venus for brightness. Its progress across the sky can seem so slow that you might mistake it for a star unless you track its movement for several nights.

Saturn. You will not see Saturn's famous rings with the unaided eye, but the planet is bright enough to find. Like Jupiter, Saturn takes a long time to show movement, so consult an almanac or guidebook before scanning the heavens for it.

Uranus. This distant planet is barely visible to the naked eye under even good viewing conditions. It moves very slowly, so to the unaided eye it looks like an average star. Through a telescope it appears pale green.

Planets do not twinkle like stars because they have a measurable disk, and more light reaches Earth. So, the steadiness of the light is a good indication that you are looking at a planet.

Asteroids, Comets, and Meteoroids

Other members of the Sun’s family include asteroids, comets, and meteoroids—sometimes considered “cosmic debris.”

Asteroids

Asteroids are minor planets of the Sun. Estimates of their number range into the millions. Some are only a few feet in diameter. The largest, Ceres, is about 580 miles across.

Most asteroids orbit the sun in the huge expanse of space between Mars and Jupiter known as the asteroid belt or main belt. Sometimes asteroids get knocked out of the main belt into the inner solar system. Asteroid fragments strike Earth every day, and scientists believe several large asteroids have slammed into Earth over the years.



Ida the asteroid

Comets

Comets are often described as dirty snowballs because they are made of frozen gases embedded with rock and dust particles. Most comets travel in long, oval orbits around the Sun.

When a comet nears the Sun, the intense heat causes the gases and particles that were frozen together to “melt” and vaporize. The vapor forms a “tail” that may be millions of miles long.

Some scientists believe that a huge asteroid many years ago struck near Mexico’s Yucatan Peninsula, setting off a chain of events that doomed Earth’s dinosaurs to extinction.



Comets that are bright enough to be seen without a telescope are so rare that only two or three comets may be visible from Earth every 10 or 15 years.

Meteoroids, Meteors, and Meteorites

These three are different aspects of the same members of the solar system. They start as *meteoroids*—stony or metallic materials in space. Some are microscopic, others are huge.

Every day, Earth's atmosphere collides with millions of meteoroids that burn in the tremendous heat created by the collision. If a meteoroid is large enough, the collision is visible as a streak of light across the sky—a *meteor*, or shooting star.

Some meteoroids survive the flaming fall to Earth without burning up completely. Those that make it to the ground are *meteorites*. Most meteorites are small, but the largest meteorite ever discovered weighs about 66 tons. It fell on a farm in South Africa.



The Willamette Meteorite was found in 1902 in Oregon's Willamette Valley. It weighs 15.5 tons and measures 9.8 feet long and is the largest meteorite ever found in the United States.

Meteor Showers

Some meteoroids are believed to be clusters of comet fragments that continue to orbit along the comet's old path, creating showers of meteors that blaze through the night sky as they pass through Earth's atmosphere. Some noteworthy meteor showers are listed here. They are named for the constellations from which they appear to come.

Shower	Date of Maximum
Quadrantid	January 3
Lyrid	April 21
Eta Aquarid	May 4
Delta Aquarid	July 29
Perseid	August 12
Orionid	October 22
South Taurid	November 4–6
Leonid	November 11–13
Geminid	December 12



The Moon—Our Nearest Neighbor

The Moon was humankind's first target in exploration beyond Earth. People first studied the Moon with just their eyes, then with Earth-based telescopes, then with robots in space. In 1968, explorers flew to the Moon and studied it from orbit. The following year, U.S. astronauts landed on the Moon and brought back rock and soil samples.

Several times between 1969 and 1972, U.S. astronauts explored the lunar surface and left behind scientific instruments to help scientists learn more about Earth's natural satellite. A few robotic probes have studied the Moon in the decades since, but the Moon remains a fascinating place with many unanswered questions.

The Face of the Moon

The Moon's surface is highly uneven, covered with mountains, plains, and valleys, and pitted with craters. The Moon is barren, without vegetation. It has no atmosphere and there are only traces of water. There are no clouds, no fog, and no snow to block our view of its surface.

These conditions also cause extreme surface temperatures. During a typical lunar day, which lasts two weeks, the Moon's surface becomes much hotter than water's boiling point on Earth. During lunar nights, which also last two weeks, the surface temperature plummets to more than 300 degrees below freezing.

The soil samples astronauts brought back from the Moon lack many essential minerals, but they are not poisonous to plants. Researchers mixed a tray of lunar soil with dirt and grew plants in it.

Even though one side of the Moon always faces away from Earth, both the near side and the far side of the Moon receive the same amounts of sunlight. There really is no "dark side of the Moon."

Mountains, Seas, and Craters

Go out at night and take a good look at the Moon. You will see lighter areas and darker areas. The darker areas were called *maria* (MAHR-ee-ah), or seas, because the astronomers who pointed the first crude telescopes at the Moon in the 17th century thought these were large bodies of water. The lighter areas were called *terrae* (TEH-ray), or lands. Look at the Moon through binoculars and you can easily see how early astronomers might have reached that conclusion.

Seas on the Moon

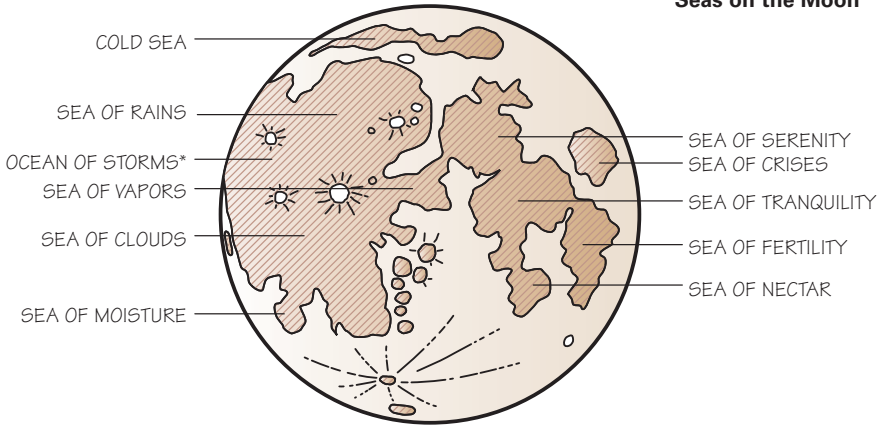

*This big plain is called an “ocean” because of its size—1,550 miles across.

We now know that the bright lunar lands are rough, mountainous highlands. The dark seas actually are broad, level plains and lowlands.

Millions of bowl-shaped cavities or pits, called craters, pockmark the Moon’s surface. Some craters span more than 100 miles wide. Some are thousands of feet deep. The Moon’s broadest craters often are called *walled plains* because their sides are much like steep cliffs rising up to mountain height.

Most lunar craters carry the names of astronomers, explorers, or ancient scientists and mathematicians, but several craters were named for mythological figures.

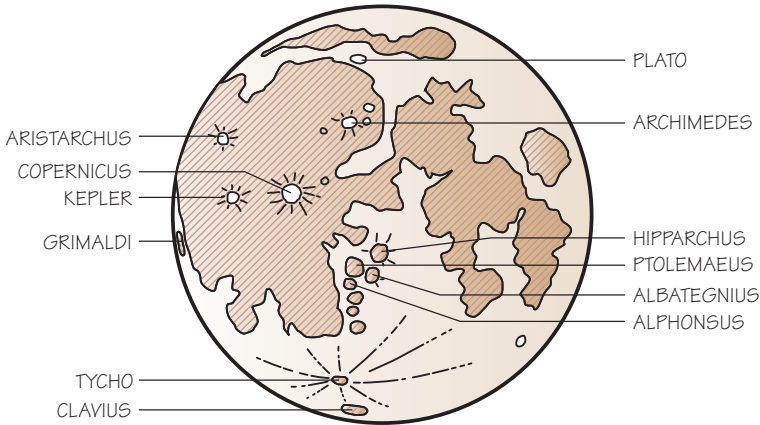

Craters and mountains on the Moon

Your sketch of the Moon for requirement 7a does not have to show a full moon, but you should select a phase that shows at least five seas and five craters. Draw the contours of visible features and label seas and prominent craters. If you have trouble identifying craters, most public libraries have astronomy books with lunar maps.

The Moon's Phases

As the Moon orbits Earth, it appears to travel westward, since we see the Moon rise in the east and set in the west. Watch the Moon's position against star patterns. As the hours pass, the Moon moves eastward relative to the stars, even though it seems to be moving westward through the night sky.

The Moon takes an average of $27\frac{1}{4}$ days to make one trip around Earth. But this is not the actual time from new moon to new moon. Earth also is moving, traveling in its orbit around the Sun. It takes the Moon about $2\frac{1}{4}$ more days to return to a position directly between Earth and the Sun, so the average time for the Moon to make one complete circuit from new moon to new moon is about $29\frac{1}{2}$ days.

The Moon's appearance varies greatly during its cycle of phases. Just after new moon we see a slender crescent. At the first-quarter phase we see the Moon half-illuminated. During the following week, a gibbous (more than half-illuminated) moon grows larger still. At full moon, the Moon is opposite the Sun in the sky so we see a completely illuminated disk.

A moon growing to full is said to be *waxing*. As it shrinks from full to new, it is *waning*.

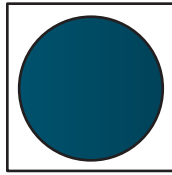

NEW MOON

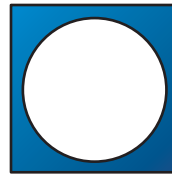

FULL MOON

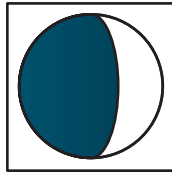

WAXING
CRESCENT

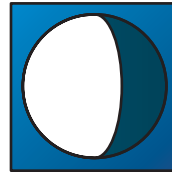

WANING
GIBBOUS

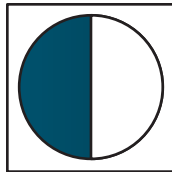

FIRST
QUARTER

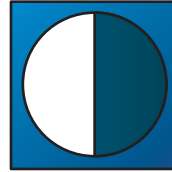

LAST
QUARTER

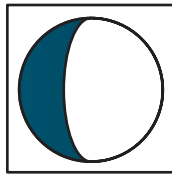

WAXING
GIBBOUS



WANING
CRESCENT

Even as it moves through its phases, the Moon is always a big rocky ball, roughly 2,200 miles across. Its appearance changes because half of the lunar surface always faces the Sun, but that lighted portion does not always face Earth.

After the full moon, it becomes a gibbous moon, then shrinks to half-illuminated as a third-quarter or last-quarter moon, then becomes a crescent moon again. Finally it returns to the new-moon phase, where it is invisible in the Sun's glare.

The Moon's position in the sky is slightly different each night, and it rises later each night, too. With each day, the Moon rises an average of about 50 minutes later, and it drops about 13 degrees farther behind in relation to the Sun.

One of the easiest ways to sketch the phases and daily positions of the Moon is to start your observations when the Moon is somewhere in the southwestern sky. On your first night of observing, draw a couple of the constellations that are visible. Next, draw in the Moon and write the date beside it on your sketch. At the same hour on other nights, add the Moon's new position.

The Moon's Orbit

The Moon orbits Earth in an ellipse, or slightly flattened circle, at an average speed of 2,300 miles per hour. Its average distance from Earth is 238,857 miles. Two forces work to keep the Moon orbiting Earth. The first force is called *inertia*, the tendency of an object in motion to continue in motion in a straight line.

If the Moon traveled in a straight line, it would leave orbit and shoot off into space. The force that holds the Moon in its orbit is *gravity*, the same force that pulls a ball to the ground when you drop it. Gravity keeps the Moon “falling” around Earth.

Just as Earth's gravity tugs on the Moon, the Moon's lesser gravity pulls on Earth. That pull causes Earth to waver slightly as it revolves around the Sun. Lunar gravity also strongly affects Earth's ocean tides.

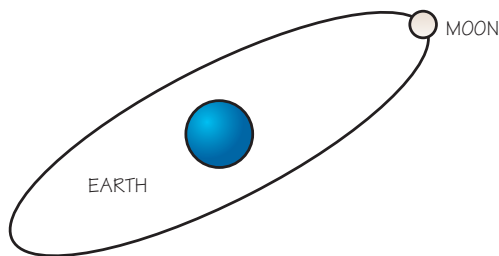

The Moon's orbit

Remember that Earth's surface is curved. If you could throw a ball fast enough so that it would land thousands of miles away, Earth would curve away from the speeding ball just as fast as the ball was dropping. When that happened, the ball would keep on falling and never strike the ground—it would be orbiting our planet.

The Moon travels faster at its *perigee*, when it is closest to Earth—221,000 miles away. It travels slower at its *apogee*, when it is farthest from Earth—about 253,000 miles away.

The *orbital plane* is the imaginary flat surface (the plane) that Earth marks out in space as it orbits the Sun. With few exceptions, all the other planets orbit in or near this same plane.

The Moon's Role in Eclipses

An eclipse happens when the Moon moves directly into line with Earth and the Sun. Eclipses can occur only at new moon or full moon, and then only when the Moon is crossing Earth's orbital plane. Eclipses usually occur several times a year.

There are two types of eclipses: solar and lunar.

A solar eclipse can be a dramatic event. It happens when the Moon passes directly between Earth and the Sun, so that the Moon's shadow strikes Earth. During a total solar eclipse, the Sun is completely blotted from view for everyone in the path of the Moon's shadow. A partial solar eclipse is visible off to one side of the path of total eclipse. The Moon appears to take a bite out of the Sun instead of fully blocking it.



Solar eclipse

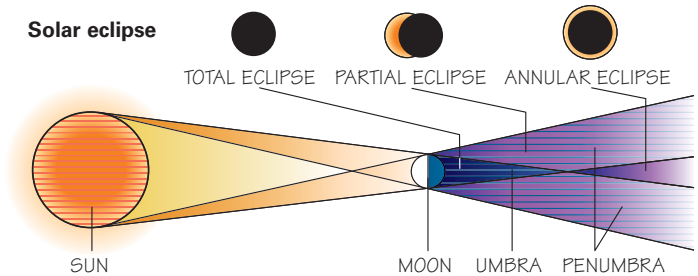

When the Moon is at a far point in its orbit, an annular eclipse may occur. In this case, the Moon appears smaller because it is farther away, and it blocks only the center of the Sun's disk, allowing sunlight to blaze all around its edges.

A lunar eclipse happens when the Moon moves directly behind Earth, passing into Earth's shadow. There are several types of lunar eclipses:

- **Partial lunar eclipse**—The Moon does not travel completely into Earth's shadow.
- **Penumbral eclipse**—The Moon is completely within the brighter, outer portion (penumbra) of Earth's shadow.

- **Umbral eclipse**—The Moon passes into the darkest inner portion (umbra) of the shadow.
- **Total lunar eclipse**—The Moon moves completely within the umbra. It is the rarest of lunar eclipses.

You don't need any special equipment to view a lunar eclipse. Lunar eclipses often go unnoticed, even though they are visible over a great area. Most people fail to notice a slight shadow, dimming, or discoloration of the full moon.

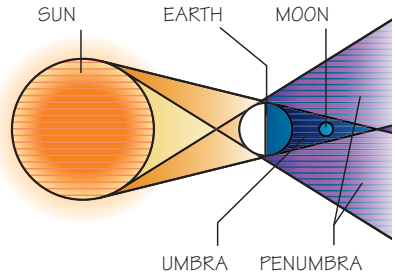

Lunar eclipse

Viewing a Solar Eclipse

Seeing a solar eclipse can be an unforgettable experience—but don't let that be the last thing you ever see. **Never** stare directly at the Sun, even for a few moments. Doing so can cause permanent blindness. *Projection is the safest way to observe solar activity.* However, when using the projection method, you should **never** look through the eyepiece.

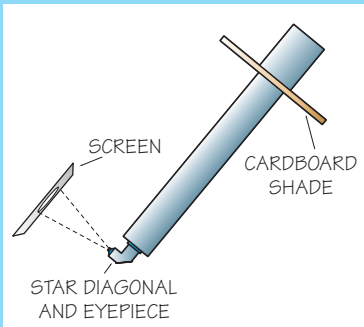

One way to safely view the Sun's image is by projecting it through the objective lens (the large end) of a telescope or binoculars and holding a piece of paper under the eyepiece like a screen. An image of the Sun will display on the paper. **Never** look into the eyepiece.

If you don't have a telescope or binoculars, use the pinhole projection method. You will need two pieces of flimsy cardboard. Using a straight pin, make a small hole in the center of one piece. Hold this first piece of cardboard above the second one, lining the cards up with the Sun as shown. The light will project an image of the Sun's eclipse through the hole in the first card onto the second card.

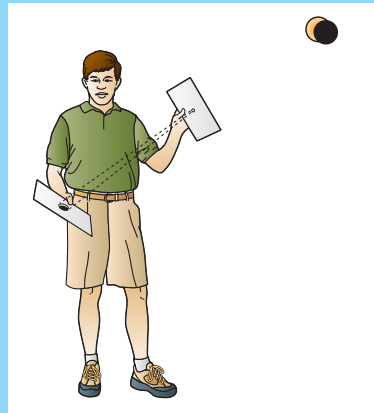

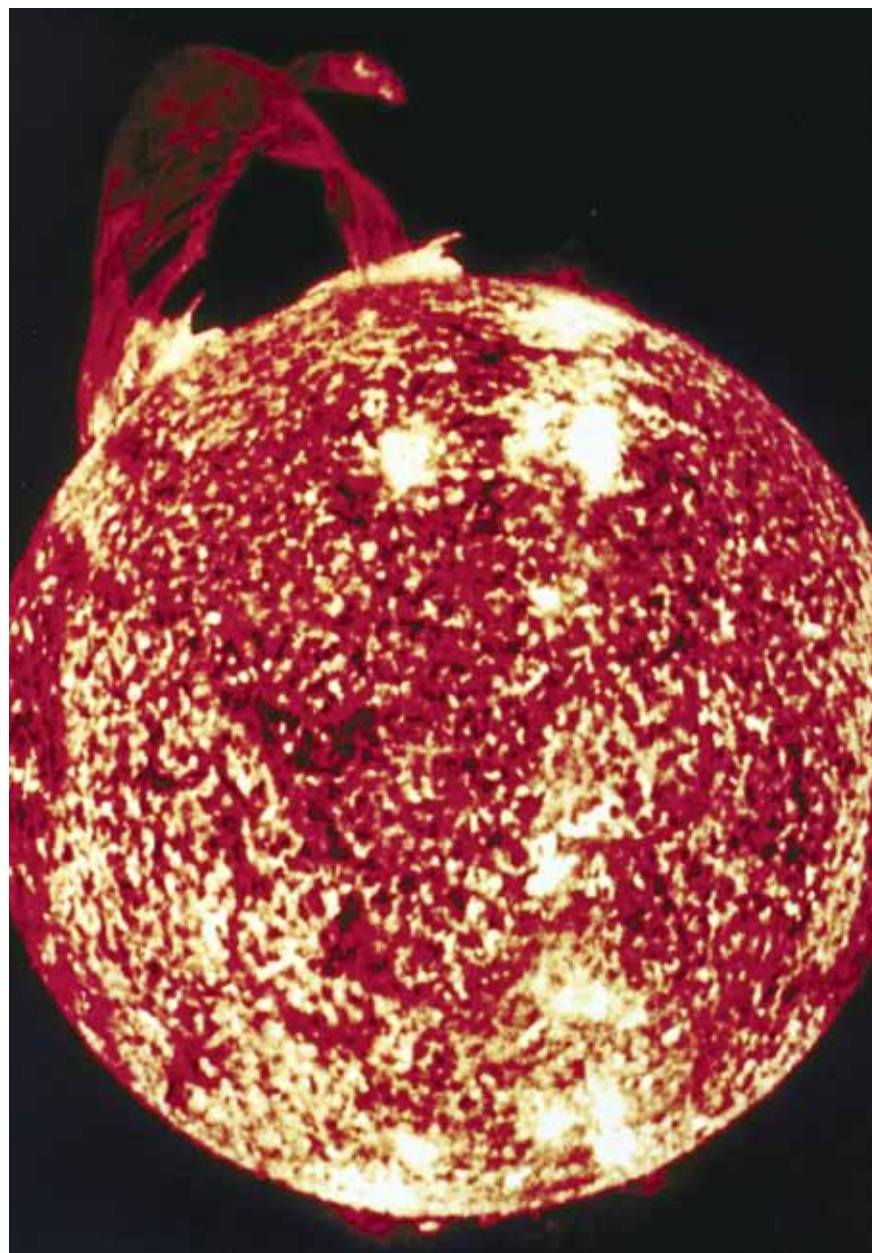

The Sun and Stars

The Sun is a huge ball of hot gas about 93 million miles from Earth. It contains 99.86 percent of the mass of the entire solar system. If you imagine the Earth as the size of a grape, then the Sun is about 5 feet high—the size of a small refrigerator.

The Sun is made mainly of hydrogen and helium. Energy is released at the Sun's core as hydrogen changes into helium during nuclear fusion reactions. Every second, the Sun converts 564 million tons of hydrogen into 560 million tons of helium. Four million tons of matter are released as energy the Sun radiates into the solar system.

The Sun produces enough energy every second to meet the needs of the whole world for more than 1,000 years.



The Sun From the Inside Out

The *photosphere* is the Sun's outer surface—the visible layer from which most of the Sun's radiation and light escape.

In the *convective zone*, energy is carried by rising and falling currents of hot gas called *convective cells*.

The *radiative zone* is the section where energy leaves the core.

The *core* is the center of the Sun, where nuclear reactions take place. The temperature at the core is close to 29 million degrees. The core occupies 2 percent of the Sun's volume but has 60 percent of its mass.

Above the photosphere lies the hot gas of the *chromosphere* ("sphere of color"), which is in violent motion. The chromosphere may be seen briefly during total solar eclipses as a reddish rim around the Sun.

Above the chromosphere is the *corona* ("crown"), which extends outward from the Sun in the form of the "solar wind."

Sunspots

Sunspots are cooler areas on the Sun (but still about 7,000 degrees F). They appear in the photosphere as pairs or groups of dark spots that can measure more than 20,000 miles across. When sunspots are numerous, the total energy coming from the Sun increases slightly. Hot material near a sunspot can burst out from the Sun in what is known as a *solar flare*.

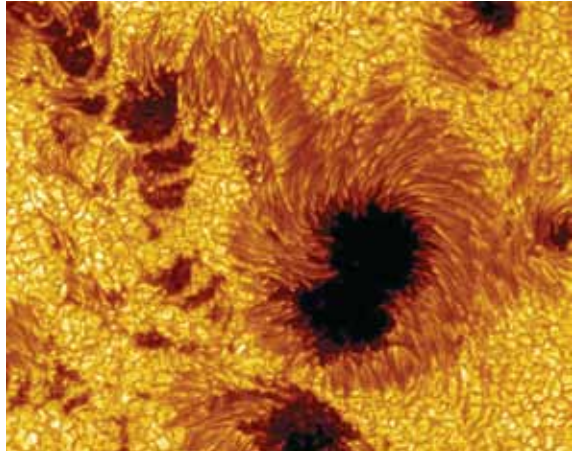

Sunspots are not permanent features of the Sun's surface. They come and go in cycles, usually over a period of about 11 years.

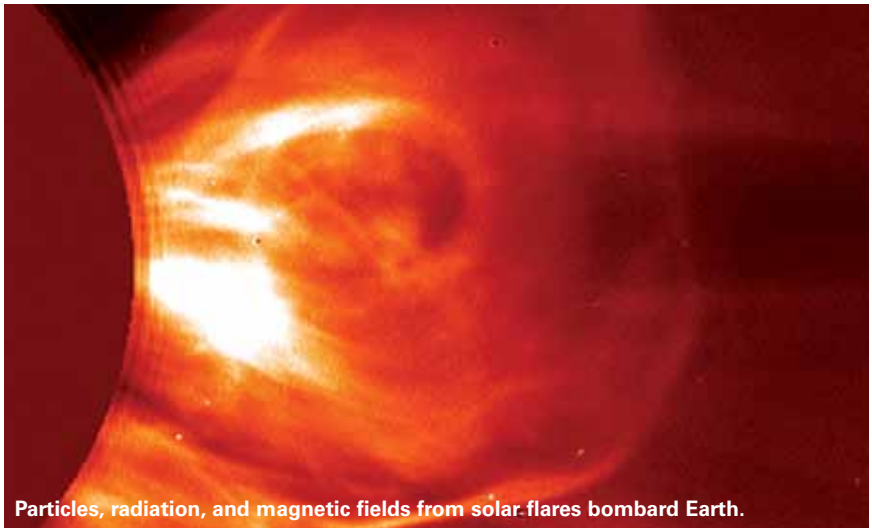

Particles, radiation, and magnetic fields from solar flares bombard Earth.

Sunspots can cause static and drown out radio signals on Earth. If the energetic flow from the Sun is strong enough, it can cause power surges, damage sensitive electronics, and overload power systems on Earth.

The Sun and Earth's Weather

The Sun's energy drives weather and climate on Earth. It burns off Earth's moisture by evaporation, heats the atmosphere, and creates wind when one air mass becomes hotter than another. Clouds condense from water vapor that has evaporated from the oceans, and rain from these clouds returns water to the oceans.

The Reason for Our Seasons

Earth has seasons because of its tilted axis, which keeps the northern hemisphere tipped toward the Sun for half the year and away for the other half. The northern hemisphere gets more direct sunlight in summer, and less sunlight six months later in winter. Thus, our region receives and retains less heat from the Sun during the winter.

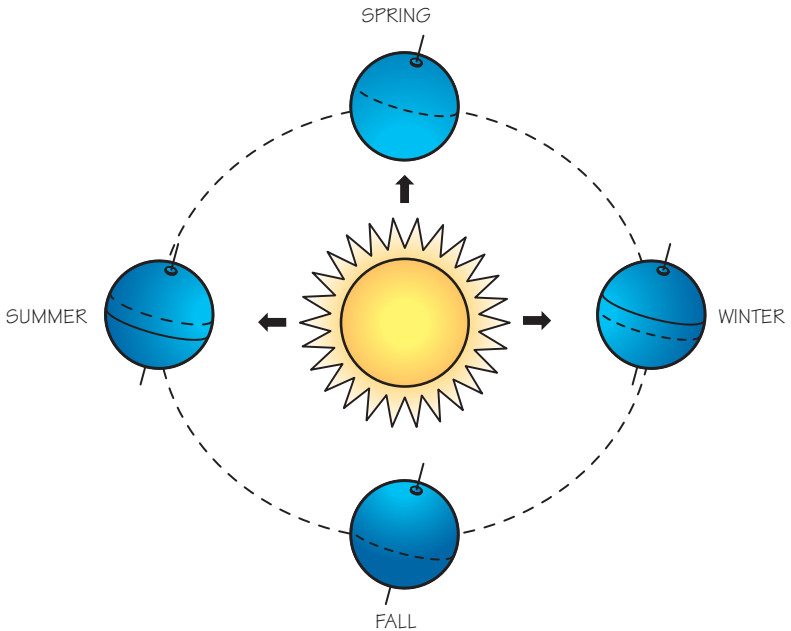

From our viewpoint on Earth, the Sun seems to rise in the east and set in the west. But that is actually true only on the first day of spring and the first day of fall. In the winter, the Sun rises southeast and sets southwest. During summer, it rises northeast and sets northwest.

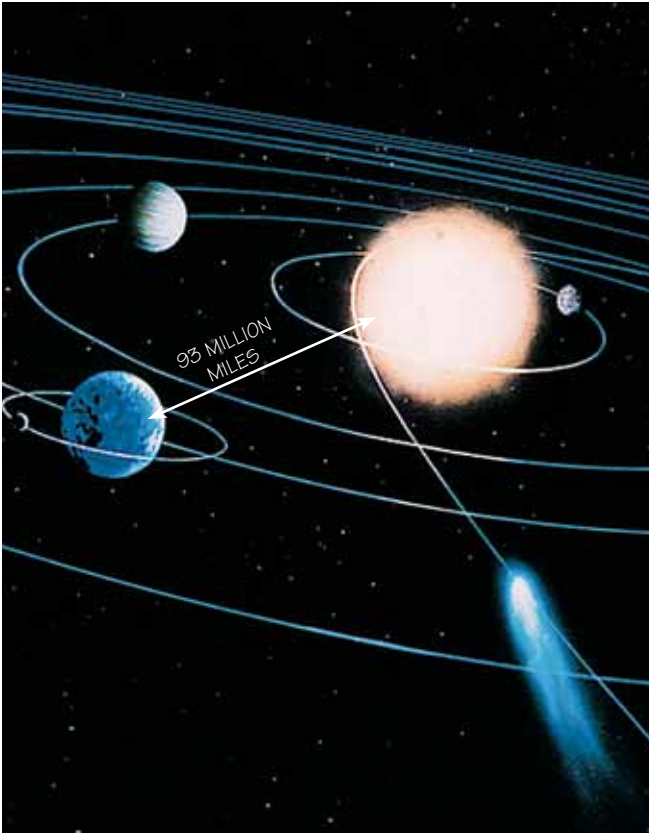

The average distance from Earth to the Sun is 93 million miles. In July, we are 94.5 million miles from the Sun; around January 1 we are "only" 91.4 million miles away.

Viewing the Sun

It bears repeating: **Never** view the Sun directly; your eyesight is too precious to risk. Telescope filters are not recommended because you are still looking in the Sun's direction, so part of your line of vision falls outside the telescope lens. Also, filters can shatter, leaving the eyes unprotected, which can blind the observer instantly. *View the Sun only by projection.*

Star Quality

Stars are divided into color categories, from hottest to relatively coolest: blue and blue-white, white, yellow, orange, and red. Stars are referred to this way because they appear to be these colors when observed through a telescope.

Blue and Blue-White Stars. The hottest of all stars appear blue or blue-white. Their temperatures range from 18,000 degrees F to more than 45,000 degrees F. An example of a hot, blue-white star is Rigel in Orion.

White Stars. White stars have temperatures from 13,500 degrees F to about 18,000 degrees F. Sirius in Canis Major—the brightest star in our sky (not counting our sun)—is a white star.

Yellow Stars. Yellow stars are cooler, at temperatures of about 9,000 to 13,500 degrees F. The Sun is a yellow star, and so is Capella in Auriga.

Orange Stars. Orange stars are between 6,000 and 9,000 degrees F. Arcturus in Boötes is an orange star.

Red Stars. Red stars, the “coolest,” are cooler than 6,000 degrees F. One of the brightest stars, Betelgeuse, is a red star.

Brightness

Brightness is not measured the same way as color. Just because a star is not as hot as others does not mean it is not as bright.

A bright star is not necessarily large, either. Some of the brightest stars are smaller than other, fainter stars. A star’s brightness in our sky depends on its actual brightness or luminosity and its distance from us. A star may appear bright in our sky either because it is genuinely very bright or because it is relatively close to Earth.



A star's actual brightness is not the same as its apparent magnitude. A star can be really bright and yet, if it is an enormous distance from Earth, it may appear faint in our sky. The opposite also is true: A nearby star that is not terribly bright can shine brilliantly in our sky. Sirius, for example, is just 9 light-years from Earth. It shines more brightly in our sky than does Rigel, which actually is a much brighter star but so far away (about 800 light-years) that it appears fainter to observers on Earth.

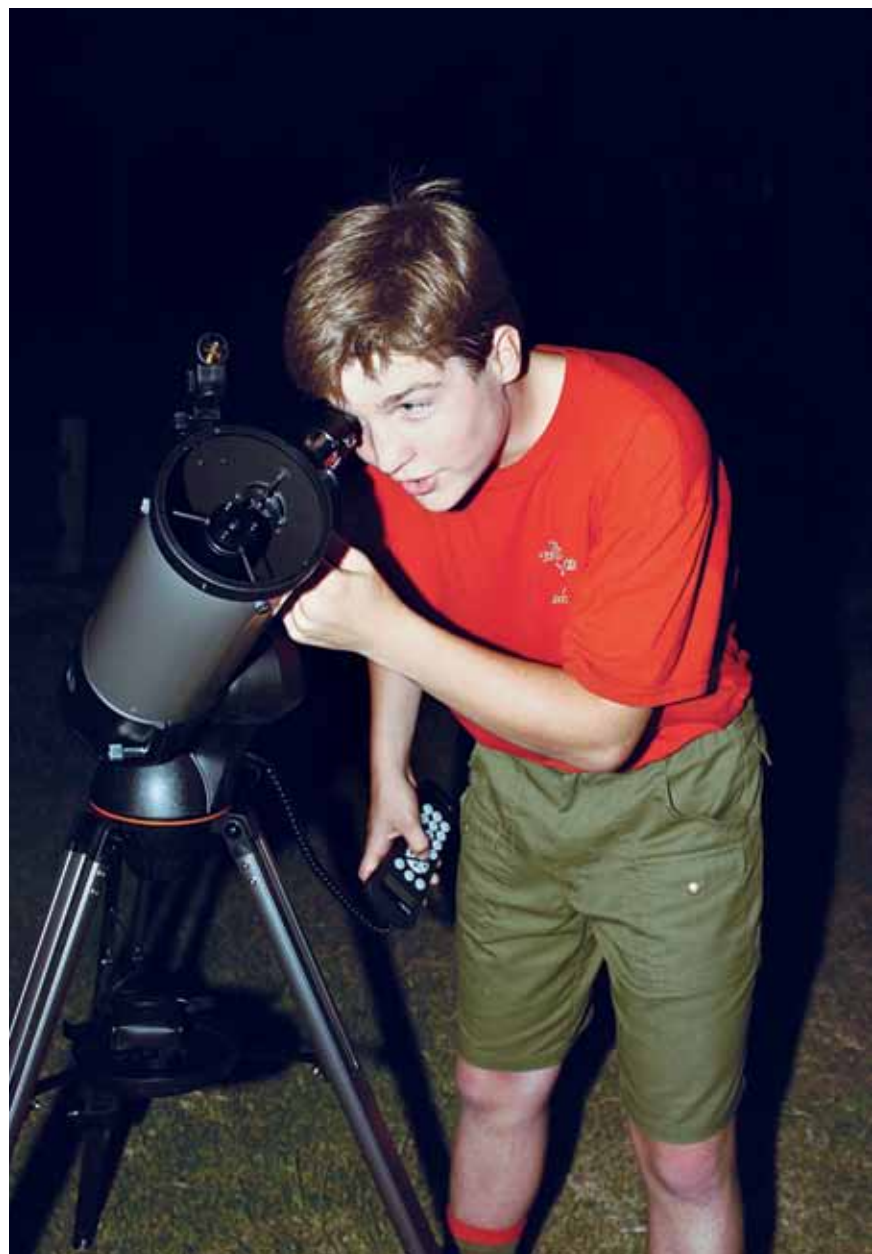

Tools of the Trade

You can observe objects in the night sky with your unaided eye. However, with binoculars or a telescope, the images you see will appear brighter and larger.

Binoculars

Binoculars are perfect for stargazing. They collect more light than the human eye, so you can see 50 times more stars with 10×50 binoculars. They also improve the clarity and intensify the colors of the stars you see.

Unlike a telescope, binoculars allow you to use both eyes to view. Binoculars show an image the right way up, whereas telescopes show objects upside down. Binoculars are easy to transport and less expensive than many telescopes.

Because of their wide field of view, binoculars are perfect for studying the surface of the Moon, scanning the Milky Way, spotting Jupiter's large moons, and viewing star clusters. An ideal size is 10350, which means the image is magnified 10 times and the main lenses are 50 millimeters in diameter. The 8340 and 7335 are also good choices.

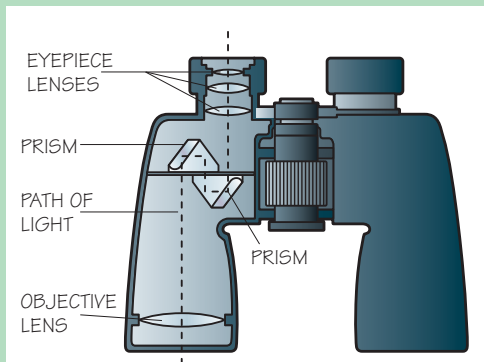

Standard binoculars



Some giant binoculars have lenses of 70 millimeters or more and magnifications of 15x to 20x. Wider lenses allow you to see more stars, but these giant binoculars are so heavy that they must be mounted on a tripod, like a telescope, for viewing.

Telescopes

Like binoculars, telescopes gather more light than the human eye. The two main types of optical telescopes—those that collect visible light—are *refracting* and *reflecting*, with a third type, the *catadioptric*, that combines features of the refractor and the reflector.

Principle of a refracting telescope

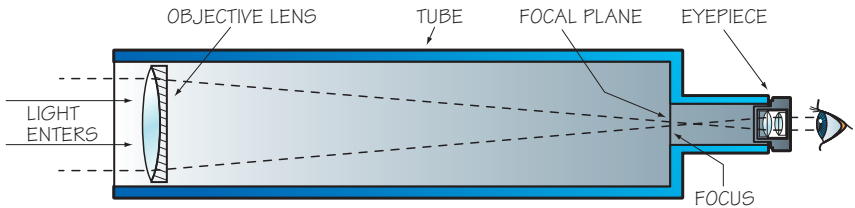

Refracting telescope

Refracting telescopes use a system of lenses. At the large end of the telescope, the objective or front lens collects and focuses light. The eyepiece, the smaller lens you look through, is at the other end. Refracting telescopes produce sharp images.

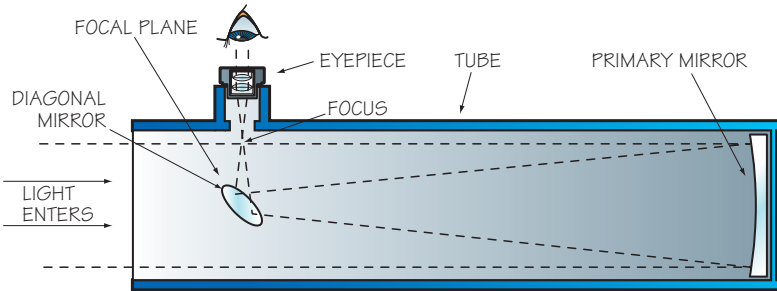

Principle of a reflecting telescope

In the reflecting telescope, a concave (bowl-shaped) mirror at the base of an open tube collects and reflects light to a second, smaller mirror near the top of the tube. The eyepiece magnifies the image that the mirrors have formed. The reflector is the most common type of telescope and a popular choice for backyard astronomers.



Reflecting telescope

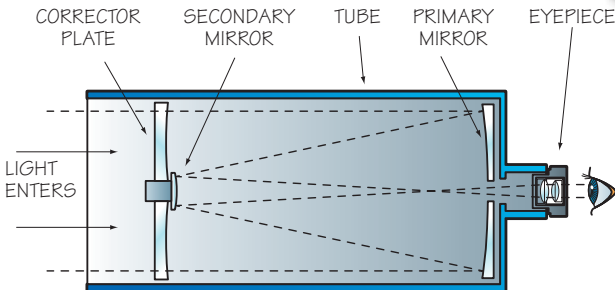

Catadioptric telescope

The catadioptric telescope, also called a reflecting-refracting telescope, combines a large front lens with two mirrors. It has a short, enclosed tube and is often portable.

One of the most famous telescopes is the Hubble Space Telescope. The size of a school bus, this solar-powered reflecting telescope is an observatory that circles outside Earth's atmosphere. Its sophisticated equipment is operated by remote control and can get spectacular images of space.



Radio and X-Ray Telescopes

Radio telescopes pick up images that astronomers would not be able to see otherwise. Radio waves from space enter the telescope's large bowl-shaped (dish) antenna, and the radio receiver picks up the signals. A computer converts the signals into images. Radio signals reveal details, including temperature and composition, of objects in space that give off radio waves.

X-ray telescopes help scientists determine the galaxy's hot spots. Cosmic X-rays—the invisible radiation emitted from very hot objects—captured by telescopes above Earth's atmosphere help scientists study dying stars, colliding galaxies, and quasars, extremely bright starlike objects that give off enormous amounts of energy.

NASA's most sensitive X-ray telescope, the Chandra X-ray Observatory, captures X-rays from the edge of the observable universe.

X-rays from distant galaxies are absorbed by Earth's atmosphere, making them impossible to study from the ground.



The dish antennas of radio telescopes are much larger than the lenses or mirrors of optical telescopes. The Arecibo Observatory in Puerto Rico has the world's largest radio telescope. Its dish measures 1,000 feet across.

Care of Binoculars and Telescopes

Following the manufacturer's recommendations and a few simple tips will help you keep your viewing equipment in good shape for many years.

- Handle binoculars and telescopes carefully and with respect. Repeated bumping, shaking, and dropping can cause the lenses to break or become misaligned.
- Keep your equipment clean. Keep lenses free from dirt, debris, fingerprints, and moisture. Use a cloth (such as a microfiber cloth) and cleaner made especially for lenses. Apply cleaner very sparingly to the cloth and never directly to the lenses.

- Keep dust from building up on lenses. Aside from normal cleaning, you may use a very soft brush (such as camel's hair), or compressed air if you take some precautions. You want to avoid any contact with the lenses and any liquid from the can. Before use, avoid shaking the can. Always hold the can upright and never tilted or directly overhead while spraying. Use a few short (a second or two) bursts of air; stop immediately if the can starts to feel cold.



- Keep water away. Protect equipment from the elements such as rain, snow, and—in particular—saltwater, which is corrosive. Repeated use in high humidity will also have a negative effect on equipment.
- In the field, use and wear the strap that comes with your binoculars to keep them safely around your neck.
- Store binoculars and telescopes in a cool (not cold), dry place, away from humidity and extreme temperatures, which will have a negative effect on the lens coatings and housing. Use the storage or carrying case and rubber eyecups (in the “up” position) that came with your equipment.

Whenever your binoculars or telescope are not in use, be sure to leave on the lens caps.



Other Instruments Used in Astronomy

A *spectroscope* separates the light coming from an object in space into a detailed pattern of colored lines, much like a rainbow, called a *spectrum*.

Mounted inside a telescope, a special eyepiece called a *filar micrometer* measures the distance between double stars. Another instrument for measuring is the *photometer*, which measures brightness, or magnitude, of light.

Astrophotography

Astronomical photography allows you to keep a record of your observations of the skies. Camera film is highly sensitive to light, and objects appear brighter and clearer in photographs than through a telescope or binoculars. In fact, the night sky's subtle colors recorded by color film are true colors.

Any 35-millimeter, single-lens-reflex (SLR) camera that has a timed-exposure setting can take good photographs of stars and planets. The "B" setting on the shutter-speed dial will hold the shutter open for as long as the release is pressed.

Film

Camera shops will have the high-speed film that is needed for astrophotography. Choose black-and-white, color-slide, or color-print film rated at 400 speed or faster, although 1000-speed film might yield the best results. Slide films work well for astrophotography because they tend to show more accurately than print films what the camera saw.

When having color-print film developed, be sure to tell the photo dealer your film has night-sky or star pictures on it. Give the technician samples of good astrophotos so you won't get back prints that show the night sky in a weird shade of green or purple.

Taking Astrophotos

Begin to set up your celestial studio by outfitting your camera with an inexpensive cable shutter release. Set the film-speed dial to correspond with the film you are using. Set the lens at the smallest number on the f-stop ring, set the shutter-speed dial on “B,” and set the focus ring at infinity. Place the camera on a tripod or other solid support and aim it at the area you want to shoot.

On a very dark night you can leave the shutter open for minutes—or even hours—to capture the stars’ movement or even a meteor.



When you are ready to shoot, use the cable shutter release to open the shutter for 15 seconds, then try exposures of 30 and 60 seconds. (Remember to advance the film after each shot.)



As the stars move across the sky, longer exposures will give you star trails, a record of the path in the sky taken by the stars.

Digital Photography

If you have used a digital camera, you know that one advantage it has over conventional film-loaded cameras is that you get instant results. A digital camera might not, however, be the best current choice for astrophotography. Pictures taken on film tend to produce sharper images and more accurate colors. Many digital cameras have automatic shutter speed and aperture, so you can't adjust the exposure time.

If you want to use a digital camera for astrophotography, shoot bright subjects like the moon. Exposure times possible with many digital cameras are limited to a few seconds at most—too short for all but the brightest stars and objects like the Moon and bright planets. Galaxies and nebulae are too faint. You may want to experiment with the black-and-white mode if your camera has that feature. Pictures shot in black and white can appear sharper than color images.

Astronomical CCD Cameras

There are digital cameras used especially for astrophotography. Just like consumer-type digital cameras, they use a charge-coupled device (CCD) instead of film to record images. But the CCD in an astronomical camera is more sensitive to light than photographic film, so a digital exposure doesn't need to be as long to capture the same amount of detail. A one-minute CCD exposure records about the same detail as a 30-minute exposure on film. The camera can capture vivid images of even faint objects.

Once used only by professional astronomers, the astronomical CCD camera is now available to amateur observers. It is fitted to the eyepiece of a telescope and linked to a home computer. With computer imaging software, images can be enhanced for brightness, color, and contrast.



Photos taken with a digital camera can be downloaded very quickly and easily to your computer.

To take pictures through a telescope, mount the camera on a separate tripod. Aim the lens into the telescope's eyepiece, centered and set as close to the eyepiece as possible. For short exposure times, hold the camera up to the eyepiece.

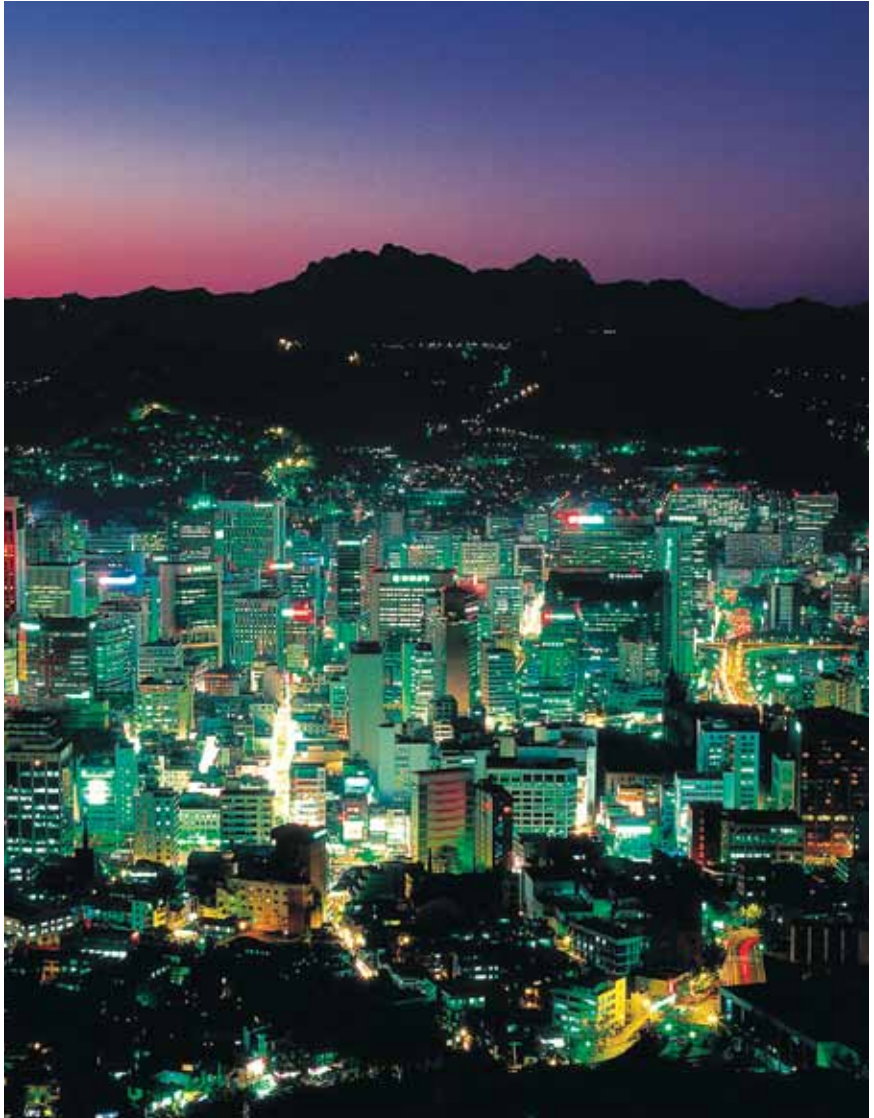

Light pollution is a serious energy waste that concerns professional astronomers and amateur observers alike. In North America electricity that wastefully illuminates the night sky costs an estimated \$1 billion a year. If steps are not taken to control light pollution, someday people may not be able to see the stars or planets.

Light Pollution

Light pollution is, very simply, too much artificial light concentrated in urban areas (areas around cities). The glare of streetlights, outdoor signs, parking-lot lights, dusk-to-dawn security lights, and outdoor fixtures around private homes creates glowing domes over cities and towns. It also can spoil your view of the night sky.

The Air Up There

Air currents also can affect observing. Turbulent air can ruin views of the Moon, planets, and faint nebulae. Windless nights are better for studying the Moon and planets. Other conditions that can affect observing are clouds, high or low humidity, and air pollution such as dust and chemicals. Faint stars may be visible only on clear, dark nights.

Seeing in a Bright Night

If light pollution interferes with your stargazing, try these tricks.

- Cover your head down to your shoulders with a dark, opaque (nontransparent) cloth. This will help prevent light from streetlights, passing cars, and the glowing sky itself from ruining your night vision.
- Observe the skies as late at night as you can. As businesses close and people go to bed, less light pollution will intrude on your stargazing.
- Look for the bright objects. Urban sky glow will not keep you from seeing Sirius, Vega, Spica, Aldebaran, or similarly strong shiners. You should also be able to spot the brightest star clusters—the Pleiades, Hyades, and Beehive clusters, for example—and the spectacular Orion Nebula.

During the last few thousand feet of its journey to Earth, starlight that has traveled trillions of miles through deep space gets washed out by bright city lights.





You and Astronomy

Plan activities to have some fun with your newfound knowledge of astronomy. Invite friends, and share your knowledge with them.

Visit a Planetarium or Observatory

Check the activity schedule of a planetarium, science museum, or observatory in your area and round up some friends to visit. While there, pay close attention to the presentations and displays. At an observatory, find out about the telescopes in use. Most of all, ask lots of questions! The people on staff not only know about astronomy, they know about practical observing in your area.

Plan an Observing Session

Develop an observing plan for a session when you will set up a telescope or observe with binoculars. Assemble the charts and guidebooks you will need. Prepare a red-filtered flashlight so you can view your charts without impairing your night vision. Get a notebook or create an observing log.

Be sure to check the weather forecast and dress appropriately. Even in mild seasons like the spring, nights can get cold. It pays to have extra layers as well as gloves, a scarf, and a hat.



Scout out the area beforehand to make sure you are aware of any conditions or potential hazards on the ground that you might miss when you come back at night.

Throw a Star Party

Plan to do everything you did for your own observing session, plus more. Find a good date and a place with plenty of room for the number of people you want to invite. Considering the time of year and how far north you live, develop a list of space objects you wish to find during the star party.

Consider inviting Scouts in your troop, your neighbors, family and friends, classmates, and teachers. When you invite them, be sure to cover such subjects as weather and proper dress, observing etiquette, and safety. Encourage those who have binoculars to bring them.



Contact a local astronomy organization or club to volunteer to help with a public star party. If you are unsure whom to contact, ask at a college in your community.

Moon Observation

Date: _____ Time: _____

Telescope: _____ Power: _____

Crater(s): _____

Notes: _____

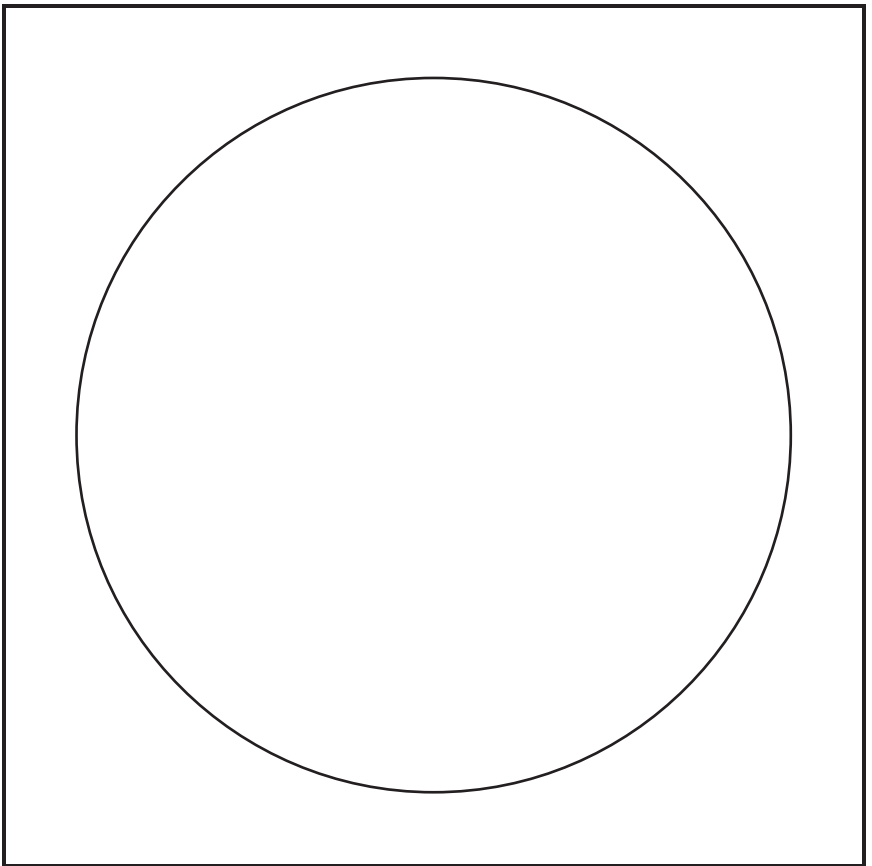

Write a summary of your observing session and share it with your counselor.

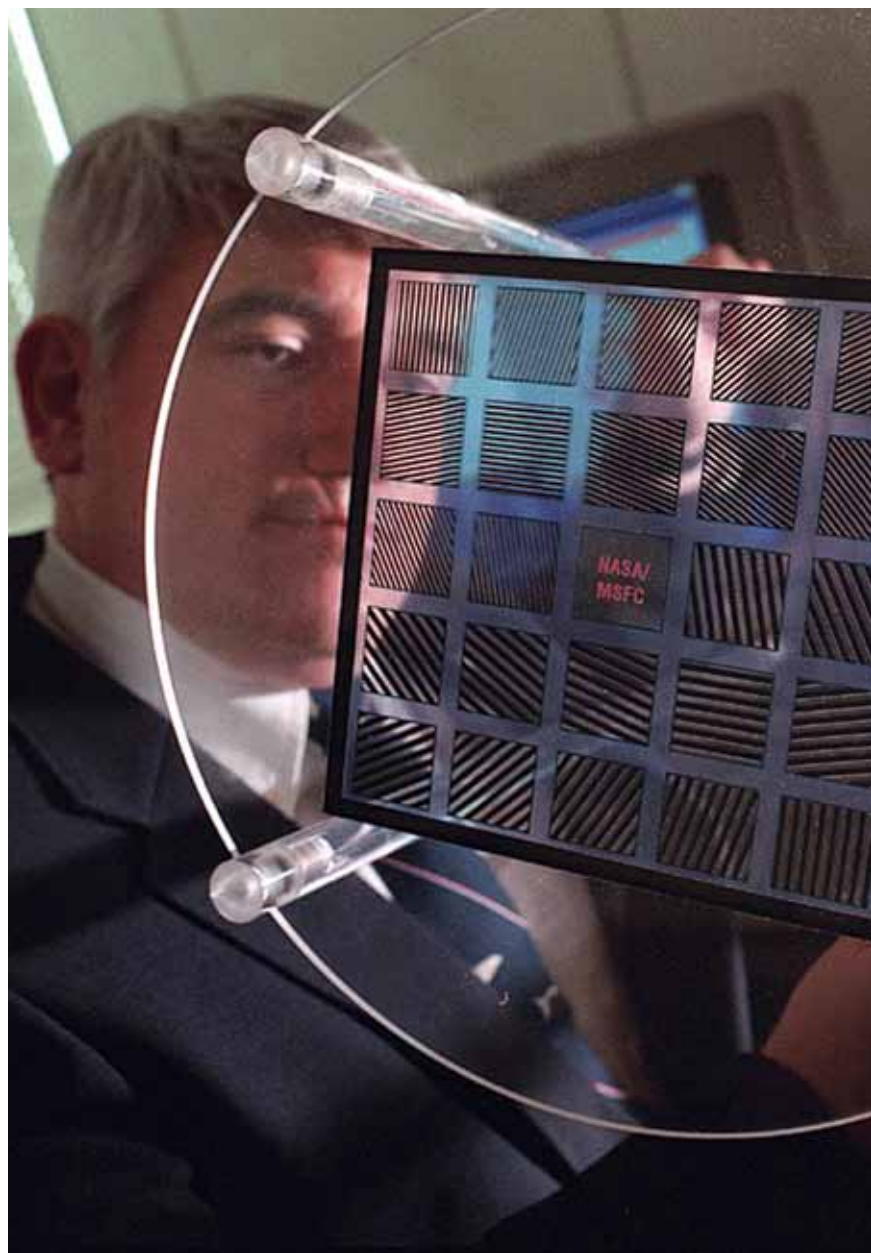

Careers in Astronomy

If you have enjoyed earning the Astronomy merit badge, you might want to consider a career in the science. To be an astronomer, you must be observant, logical, imaginative, intuitive, and curious—your goal is nothing less than to understand the nature of the universe. It helps to be patient and to have the determination to stick with a difficult problem or long project until you have seen it through, which can take years.

Astronomers typically are math and science whizzes, skilled with computers. You will need to take high school calculus or precalculus, physics, chemistry, and computer science to prepare for college astronomy.

Reading, writing, and speaking skills also are important. Astronomers give talks at professional meetings and write papers for scientific journals. So, when choosing your courses, do not neglect language, communication, and social studies.

Where Astronomers Are Found

Most astronomers teach at colleges and universities and also do some research in a particular area of astronomy, such as planetary science, solar astronomy, or the study of stars or galaxies. Many who teach astronomy may work in the physics department of their university. Often, those who teach astronomy also teach physics.

About a third of professional astronomers have careers in federal government or at government-supported national observatories and laboratories. About 10 percent of astronomers are employed in business or private industry like the aerospace field.

What Astronomers Do

Observational astronomers design and carry out observing programs with a telescope or spacecraft, but they do not spend all their time looking through the eyepiece of a telescope. They

typically spend only 10 to 30 nights per year working at an observatory or getting observations from spacecraft. And even then, they are not looking up at the heavens. They are working at computers, analyzing and interpreting the information collected by the telescope and other instruments.

People interested in astronomy also may find careers as science librarians or teachers, science writers, planetarium or science museum directors, observing technicians or assistants, telescope operators, and optical engineers. Related career opportunities might be found in computing, image processing, and instrument design and building.



Professional astronomers such as theoretical astrophysicists may never work directly with observing equipment. They often do their research using supercomputers and complex computer models.

Space for Amateurs

Serious amateur observers make important contributions to astronomy. Amateurs are the chief comet-finders. They map storms on Mars and Jupiter, track the movements of asteroids, and discover supernovas. Their thousands of telescopes, computers, and electronic cameras far outnumber the comparatively few large university and government observatories. You might prefer to remain a hobbyist, where you can do real science and you get to decide how to spend your stargazing nights.

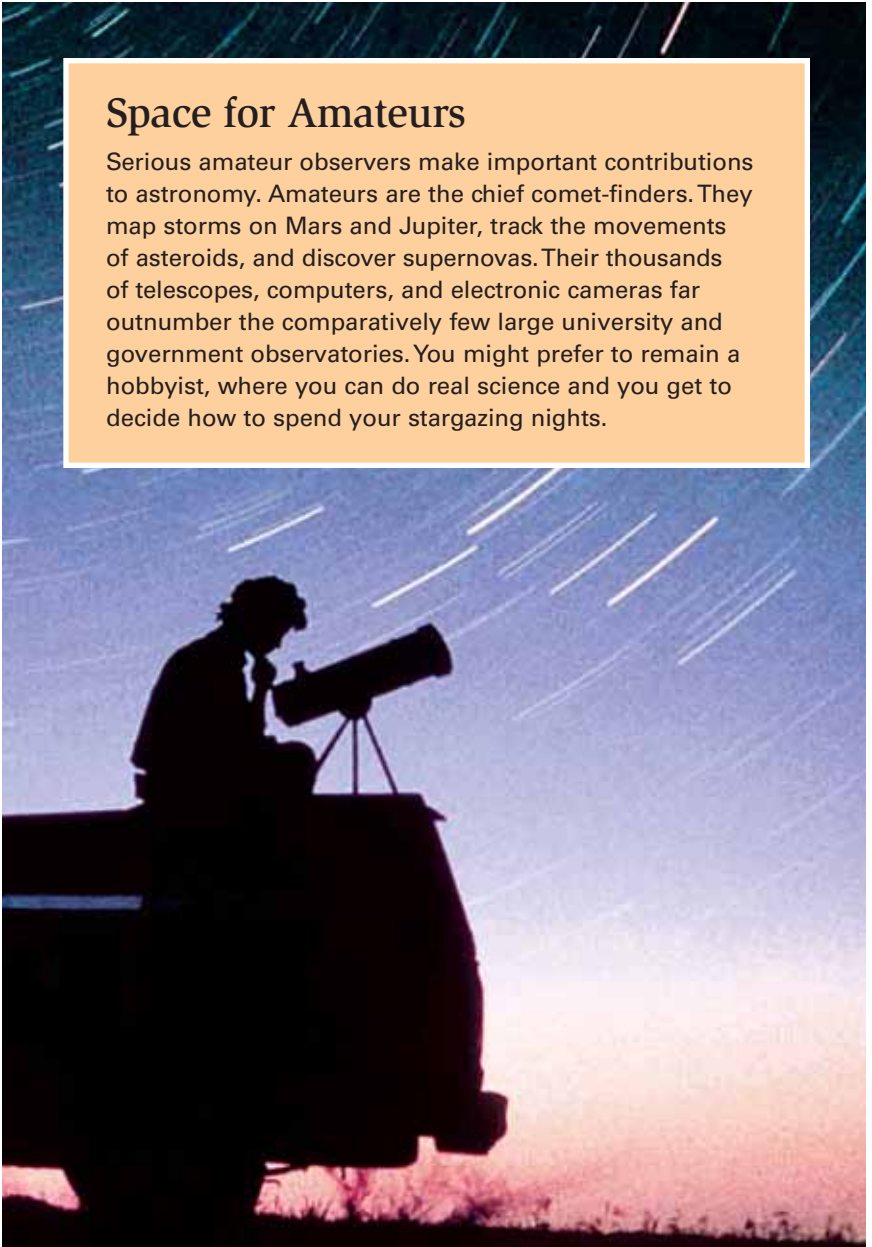



Astronomy Resources

Scouting Literature

Deck of Stars; Night Sky pocket guide; *Chemistry, Computers, Geology, Nuclear Science, Photography, Radio, Space Exploration*, and *Weather* merit badge pamphlets

Visit the Boy Scouts of America's official retail Web site at <http://www.scoutstuff.org> for a complete listing of all merit badge pamphlets and other helpful Scouting materials and supplies.

Books

- Brunier, Serge, and Akira Fujii. *The Great Atlas of the Stars*. Firefly Books, 2001.
- Covington, Michael A. *Astrophotography for the Amateur*, 2nd ed. Cambridge University Press, 1999.
- Davis, Kenneth C. *Don't Know Much About Space*. HarperTrophy, 2001.
- . *Don't Know Much About the Solar System*. HarperCollins, 2001.
- Dickinson, Terence. *NightWatch: A Practical Guide to Viewing the Universe*. Firefly Books, 2006.

Harrington, Philip, and Edward Pascuzzi. *Astronomy for All Ages*. Globe Pequot Press, 2000.

Lambert, David. *The Kingfisher Young People's Book of the Universe*. Kingfisher Books, 2001.

Moore, Patrick, ed. *Astronomy Encyclopedia*. Oxford Children's Books, 2002.

Price, Fred W. *The Planet Observer's Handbook*. Cambridge University Press, 2000.

Schaaf, Fred. *40 Nights to Knowing the Sky: A Night-by-Night Skywatching Primer*. Owl Books, 1998.

Trefil, James. *Other Worlds: Images of the Cosmos from Earth and Space*. National Geographic, 1999.

CDs, DVDs, and Videos

- Amazing Universe III*. Hopkins Technology, 1995, CD-ROM.
- IMAX Cosmic Voyage*. Warner Home Video, 1996, DVD.
- Savage Sun*. Discovery Channel, 1999, videocassette.
- The Solar Empire: A Star is Born*. Discovery Channel and The Learning Channel, 1997, videocassette.

Magazines

Astronomy

Kalmbach Publishing Co.
21027 Crossroads Circle
P.O. Box 1612
Waukesha, WI 53187-1612
Toll-free telephone: 800-533-6644
Web site: <http://www.astronomy.com>

Sky and Telescope

Sky Publishing
90 Sherman St.
Cambridge, MA 02140
Toll-free telephone: 866-644-1377
Web site:
<http://www.skyandtelescope.com>

Organizations and Web Sites

The Astronomical League

9201 Ward Parkway, Suite 100
Kansas City, MO 64114
Telephone: 816-333-7759
Web site: <http://www.astroleague.org>

National Aeronautics and Space Administration

NASA Headquarters
Suite 5K39
Washington, DC 20546-0001
Telephone: 202-358-0001
Web site: <http://www.nasa.gov>

National Optical Astronomy Observatory

950 North Cherry Ave.
Tucson, AZ 85719
Telephone: 520-318-8000
Web site: <http://www.noao.edu>

National Radio Astronomy Observatory

520 Edgemont Road
Charlottesville, VA 22903
Telephone: 434-296-0222
Web site: <http://www.nrao.edu>

The Planetary Society

65 North Catalina Ave.
Pasadena, CA 91106-2301
Telephone: 626-793-5100
Web site: <http://planetary.org>

Sky Maps

Web site: <http://www.skymaps.com>

Solar System Exploration: Planets

Web site: <http://sse.jpl.nasa.gov/planets/index.cfm>

Space Telescope Science Institute

3700 San Martin Drive
Baltimore, MD 21218
Telephone: 410-338-4444
Web site: <http://www.stsci.edu>

SpaceWander.com™

Web site: <http://www.spacewander.com>

spaceweather.com

Web site: <http://www.spaceweather.com>

Acknowledgments

The Boy Scouts of America thanks William Cress, Beaver Falls, Pennsylvania, an advanced nuclear technologist by trade who is a longtime Astronomy merit badge counselor and an experienced amateur astronomer. We appreciate his knowledge, advice, and support immensely in helping to update the *Astronomy* merit badge pamphlet. He gathered an impressive group of fellow astronomers to assist in this effort, and we thank them here, as well:

- Jane Konrad, Pittsburgh Regional Center for Science Teachers and the Pennsylvania NASA Educator Resource Center
- Dan Malerbo, Buhl Digital Dome, Carnegie Science Center, Pittsburgh, Pennsylvania
- Tim Manka, retired science instructor, an Astronomy merit badge counselor since 1966
- Jean Philpott, Buhl Digital Dome, Carnegie Science Center, Pittsburgh, Pennsylvania
- Pat Plunkett, Wheeling (West Virginia) Jesuit University
- Tom Reiland, founder, Wagman Observatory, western Pennsylvania

The Boy Scouts of America is grateful to Al Dorn and the Omaha Astronomical Society for their expertise, assistance, and guidance in updating requirements for the Astronomy merit badge and support in developing the new text for the 2004 edition. The Society's Web site, found at <http://www.omhaastro.com>, provides a wealth of information for the beginner amateur astronomer as well as those who have developed a more serious interest.

Photo and Illustration Credits

- Ablestock.com—page 60
- Brand X Pictures—page 61
- Comstock—page 29 (*top*)
- Digital Vision™ Astronomy & Space CD—page 51
- Gemini Observatory/NOAO*/ AURA†/National Science Foundation, courtesy—page 64
- Goodshoot—page 5
- NAIC—Arecibo Observatory, a facility of the National Science Foundation, courtesy—page 59
- NASA, courtesy—cover (*galaxy*); pages 27 (*top*), 47, 74 (*top*), and 76
- NASA, Jet Propulsion Laboratory, courtesy—pages 27 (*bottom*), 29 (*bottom*), 30, and 36 (*top*)
- NASA, Marshall Space Flight Center, courtesy—page 72

*National Optical Astronomy Observatory

†Association of Universities for Research in Astronomy

National Optical Astronomy
Observatory/Association of
Universities for Research in
Astronomy/National Science
Foundation, courtesy—
page 74 (*bottom*)

NOAO/AURA/NSF, courtesy; photo by
David Talent—page 23

©Photos.com—cover (*solar system
model, satellite dish, moon, Mars*);
pages 6, 9, 24, 26, 28 (*all*), 36
(*bottom*), 38, 44 (*top*), 46, 58, 66–67
(*both*), 69, 75, and 76 (*background*)

Royal Swedish Academy of Sciences,
courtesy—page 49 (*top*)

SOHO Project, NASA Goddard Space
Flight Center, courtesy—
page 49 (*bottom*)

Wikipedia.org/Dante Alighieri,
courtesy—page 37

Wikipedia.org/Geoffrey Notkin,
courtesy—cover (*meteorite*)

All other photos are the property of
or are protected by the Boy Scouts
of America.

John McDearmon—all illustrations on
pages 7, 12, 15, 17, 19, 21, 31–32,
34, 40–45 (*all illustrations*), 48, 50,
and 55–57

Brian Payne—page 10

MERIT BADGE LIBRARY

Though intended as an aid to Boy Scouts, Varsity Scouts, and qualified Venturers in meeting merit badge requirements, these pamphlets are of general interest and are made available by many schools and public libraries. The latest revision date of each pamphlet might not correspond with the copyright date shown below, because this list is corrected only once a year, in January. Any number of merit badge pamphlets may be revised throughout the year; others are simply reprinted until a revision becomes necessary.

If a Scout has already started working on a merit badge when a new edition for that pamphlet is introduced, *he may continue to use the same merit badge pamphlet to earn the badge and fulfill the requirements therein.* In other words, the Scout need not start all over again with the new pamphlet and possibly revised requirements.

Merit Badge Pamphlet	Year	Merit Badge Pamphlet	Year	Merit Badge Pamphlet	Year
American Business	2002	Engineering	2008	Photography	2005
American Cultures	2005	Entrepreneurship	2006	Pioneering	2006
American Heritage	2005	Environmental Science	2006	Plant Science	2005
American Labor	2006	Family Life	2005	Plumbing	2004
Animal Science	2006	Farm Mechanics	2008	Pottery	2008
Archaeology	2006	Fingerprinting	2003	Public Health	2005
Archery	2004	Fire Safety	2004	Public Speaking	2002
Architecture	2008	First Aid	2007	Pulp and Paper	2006
Art	2006	Fish and Wildlife		Radio	2008
Astronomy	2004	Management	2004	Railroading	2003
Athletics	2006	Fishing	2009	Reading	2003
Automotive Maintenance	2008	Fly-Fishing	2009	Reptile and	
Aviation	2006	Forestry	2005	Amphibian Study	2005
Backpacking	2007	Gardening	2002	Rifle Shooting	2001
Basketry	2003	Genealogy	2005	Rowing	2006
Bird Study	2005	Geology	2005	Safety	2006
Bugling (see Music)		Golf	2002	Salesmanship	2003
Camping	2005	Graphic Arts	2006	Scholarship	2004
Canoeing	2004	Hiking	2007	Scuba Diving	2009
Chemistry	2004	Home Repairs	2009	Sculpture	2007
Cinematography	2008	Horsemanship	2003	Shotgun Shooting	2005
Citizenship in the		Indian Lore	2008	Skating	2005
Community	2005	Insect Study	2008	Small-Boat Sailing	2004
Citizenship in the Nation	2005	Journalism	2006	Snow Sports	2007
Citizenship in the World	2005	Landscape Architecture	2008	Soil and Water	
Climbing	2006	Law	2003	Conservation	2004
Coin Collecting	2008	Leatherwork	2002	Space Exploration	2004
Collections	2008	Lifesaving	2008	Sports	2006
Communication	2009	Mammal Study	2003	Stamp Collecting	2007
Composite Materials	2006	Medicine	2009	Surveying	2004
Computers	2009	Metalwork	2007	Swimming	2008
Cooking	2007	Model Design and Building	2003	Textile	2003
Crime Prevention	2005	Motorboating	2008	Theater	2005
Cycling	2003	Music and Bugling	2003	Traffic Safety	2006
Dentistry	2006	Nature	2003	Truck Transportation	2005
Disabilities Awareness	2005	Nuclear Science	2004	Veterinary Medicine	2005
Dog Care	2003	Oceanography	2009	Water Sports	2007
Drafting	2008	Orienteering	2003	Weather	2006
Electricity	2004	Painting	2008	Whitewater	2005
Electronics	2004	Personal Fitness	2006	Wilderness Survival	2007
Emergency Preparedness	2008	Personal Management	2003	Wood Carving	2006
Energy	2005	Pets	2003	Woodwork	2003

BOY SCOUTS OF AMERICA • SUPPLY GROUP

NATIONAL DISTRIBUTION CENTER

2109 Westinghouse Boulevard
P.O. Box 7143
Charlotte, NC 28241-7143

www.scoutstuff.org

DIRECT MAIL CENTER

P.O. Box 909
Pineville, NC 28134-0909
For fast credit card orders—

VISA, MasterCard, American Express—
call BSA operators toll-free
1-800-323-0732



NORTHERN TIER



EAGLE SCOUT



FLORIDA SEA BASE



PHILMONT SCOUT RANCH

ON THE ROAD TO HIGH ADVENTURE

THE SUPPLY GROUP IS
READY TO BE A PARTNER
ON YOUR TRAIL TO
EAGLE THROUGH HIGH
ADVENTURE. THE
ADVENTURE IS YOURS,
AND WE ARE READY
WITH THE GEAR YOU
WILL NEED. YOU CAN
DEPEND ON THE LATEST
IN LIGHTWEIGHT,
DURABLE, QUALITY
GEAR THAT WILL
MEET AND SURPASS
YOUR TOUGHEST
REQUIREMENTS.



WWW.SCOUTSTUFF.ORG

SKU 610461



7 30176 35832 1
35859 2010 Printing